



Fits In. Watches Out.

The D25M Dome camera adapts perfectly to any task. Exchangeable lenses, various mounting and configuration options including Vandalism Set support unlimited possibilities.



Outdoor Wall Mount



On-Wall Set 0°



On-Wall Set 10°



In-Ceiling Set



Vandalism Set

 5MP
Sensor

 MxLEO

 vPTZ

 MxBus

 USB

 +50°
-30°

 IP65

Innovations – Made in Germany

The German company MOBOTIX AG is known as the leading pioneer in network camera technology and its decentralized concept has made high-resolution video systems cost-efficient.

MOBOTIX AG • D-67722 Langmeil • Tel: +49 6302 9816-103 • Fax: +49 6302 9816-190 • sales@mobotix.com

THE MOBOTIX INFORMATION CHANNELS



Support on the MOBOTIX Website

www.mobotix.com/other/Support



The MOBOTIX Video Tutorials

www.mobotix.com/other/Support/Tutorials



Seminars on MOBOTIX Campus

www.mobotix.com/other/Partners/Seminars



The MOBOTIX YouTube Channel

www.youtube.com/MOBOTIXAG

MOBOTIX Seminars

MOBOTIX offers inexpensive seminars that include workshops and practical exercises. For more information, visit www.mobotix.com > **Seminars**.

Copyright Information

All rights reserved. *MOBOTIX*, the MX logo, *MxControlCenter*, *MxEasy* and *MxPEG* are trademarks of MOBOTIX AG registered in the European Union, the U.S.A., and other countries. *Microsoft*, *Windows* and *Windows Server* are registered trademarks of Microsoft Corporation. *Apple*, the Apple logo, *Macintosh*, *OS X*, *iOS*, *Bonjour*, the Bonjour logo, the Bonjour icon, *iPod* and *iTunes* are trademarks of Apple Inc. registered in the U.S.A. and other countries. *iPhone*, *iPad*, *iPad mini* and *iPod touch* are Apple Inc. trademarks. *Linux* is a trademark of Linus Torvalds. All other marks and names mentioned herein are trademarks or registered trademarks of the respective owners.

Copyright © 1999-2014 MOBOTIX AG, Langmeil, Germany. Information subject to change without notice!

Download the latest version of this and other manuals as PDF files from www.mobotix.com > **Support** > **Manuals**.

CONTENTS

1	Product Overview	10
1.1	D25M Overview	10
1.1.1	General Product Characteristics	10
1.1.2	Advantages and New Features	18
1.1.3	Decentralized Video System	20
1.1.4	Green IP Video	22
1.2	Technical Specifications	24
1.2.1	Lens Options, Hardware and Software Features	24
1.2.2	Camera Variants - Lenses, Hardware, Image Formats	26
1.2.3	Camera Variants - Software Features	27
1.2.4	Technical Data	28
1.3	Delivered Parts and Dimensions	30
1.3.1	D25M-IT/Secure	30
1.3.2	D25M Basic	34
1.4	Available Accessories	38
1.4.1	On-Wall Set	38
1.4.2	10° On-Wall Set	38
1.4.3	Vandalism Set	38
1.4.4	In-Ceiling Set	39
1.4.5	Outdoor Wall Mount	39
1.4.6	Corner and Pole Mount	39
1.4.7	Tinted Dome	39
1.4.8	MiniUSB Cable to MiniUSB (Straight/Angled)	39
1.4.9	MiniUSB Cable to MiniUSB (Angled/Angled)	40
1.4.10	MiniUSB Cable to USB-A Socket	40
1.4.11	Ethernet Patch Cable for Bayonet Catch	40
1.4.12	NPA-PoE-Set	40
1.4.13	MX-Overvoltage-Protection-Box	41
1.4.14	MX-NPA-Box	41
1.4.15	MX-GPS-Box	41
1.4.16	MX-232-IO-Box	42
1.4.17	ExtIO Expansion Module	42
1.4.18	Mx2wire+ Media Converter	42
1.4.19	Other Accessories	43
1.5	MOBOTIX Software	44
1.5.1	Integrated Camera Software (Firmware)	44
1.5.2	MxControlCenter	45
1.5.3	MxEasy	46
1.5.4	MOBOTIX App	47

2	Installation	48
2.1	Preparing the Installation	48
2.1.1	Ceiling and Wall Mounting	49
2.1.2	Mounting Options	51
2.1.3	Network Connection and Power Supply, UPS	52
2.1.4	Preparing the Camera Connections, MX-Overvoltage-Protection-Box	53
2.1.5	Wiring, Fire Prevention, Lightning and Surge Protection	54
2.2	Mounting the Camera Without Accessories	56
2.2.1	Mounting Instructions	56
2.2.2	Procedure for All D25M Cameras	58
2.2.3	Procedure for D25M IT/Secure	59
2.2.4	Procedure for D25M Basic	60
2.3	Mounting the Camera with the On-Wall Set	62
2.3.1	Mounting Instructions	62
2.3.2	Procedure	65
2.4	Mounting the Camera with the In-Ceiling Set	67
2.4.1	Mounting Instructions	67
2.4.2	Procedure	70
2.5	Installing the Vandalism Set	72
2.5.1	Mounting Instructions	72
2.5.2	Procedure	74
2.6	Installing the Wall Mount	76
2.6.1	Mounting Instructions	76
2.6.2	Procedure	79
2.7	Installing the Corner and Pole Mount	81
2.7.1	Mounting Instructions	81
2.7.2	Mounting to a Pole	83
2.7.3	Mounting to a Wall or Building Corner	84
2.7.4	Mounting the Wall Mount to the Corner and Pole Mount	85
2.8	Replacing the MicroSD Card	86
2.8.1	Removing a MicroSD Card	86
2.8.2	Inserting a MicroSD Card	87
2.9	Network and Power Connection	88
2.9.1	Notes on Cable Lengths and Power Supply	88
2.9.2	Connecting the D25M to the Network Using a Patch Cable	88
2.9.3	Power Supply Using a Switch	89
2.9.4	Power Supply When Connected Directly to a Computer	90
2.9.5	Power Supply with Power-Over-Ethernet Products	90
2.9.6	Connecting a USB Cable	91
2.9.7	Connecting a Two-Wire MxBus Cable	92

2.9.8	Variable PoE	94
2.9.9	Camera Startup Sequence	95
3	Operating the Camera	96
3.1	Manual and Automatic Operation - Overview	96
3.1.1	Manually Using a Computer in the 10.x.x.x IP Address Range	97
3.1.2	Automatically Using MxControlCenter or MxEasy	98
3.1.3	Automatically Using DHCP	99
3.2	First Images and the Most Important Settings	100
3.2.1	Manually Setting Up the Network Parameters in a Browser	100
3.2.2	First Images and the Most Important Settings in the Browser	102
3.2.3	First Images and Network Parameter Configuration in MxControlCenter	104
3.2.4	First Images and Network Parameter Configuration in MxEasy	109
3.2.5	Starting the Camera with the Factory IP Address	112
3.2.6	Starting the Camera with an Automatic IP Address (DHCP)	113
3.3	Adjusting Lens Focus and Correcting Lens Distortion	114
3.3.1	Aiming and Adjusting the Lens	114
3.3.2	Correcting Lens Distortion (L25 Only)	116
3.4	Virtual PTZ and Full Image Recording	118
3.4.1	Preparing the Virtual PTZ Function	118
3.4.2	Full Image Recording	120
3.5	MicroSD Card Recording	122
3.5.1	Introduction	122
3.5.2	Formatting the MicroSD Card	124
3.5.3	Activating MicroSD Card Recording	125
3.5.4	Accessing Data on the MicroSD Card	126
3.5.5	Deactivating Card Recording	126
3.5.6	Using a MicroSD Card in a Different MOBOTIX Camera	127
3.5.7	Limitations on Warranty When Using Flash Storage Media	127
3.6	Configuration in the Browser	128
3.6.1	Overview	128
3.6.2	General Browser Settings	130
3.7	Additional Notes	132
3.7.1	Weatherproofness	132
3.7.2	Password for the Administration Menu	132
3.7.3	Permanently Deactivating the Microphone	132
3.7.4	Starting the Camera with the Factory IP Address	132
3.7.5	Resetting the Camera to Factory Settings	133
3.7.6	Activating Event Control and Motion Detection	133
3.7.7	Deactivating Text and Logo Options	133
3.7.8	Deactivating the Camera Reboot	133

3.7.9	Browser	134
3.7.10	Cleaning the Camera and Lens	134
3.7.11	Legal Notes	134
3.7.12	Safety Warnings	134
3.7.13	Online Help in the Browser	135
3.7.14	Declaration of Conformity	136
3.7.15	Disposal	136
3.7.16	Disclaimer	136

Manufacturer

139



Legal Notes

Legal aspects of video and sound recording: You must comply with all data protection regulations for video and sound monitoring when using MOBOTIX products. Depending on national laws and the installation location of the D25M, the recording of video and sound data may be subject to special documentation or it may be prohibited. All users of MOBOTIX products are therefore required to familiarize themselves with all valid regulations and comply with these laws. MOBOTIX AG is not liable for any illegal use of its products.



Safety Warnings

Installation Instructions:

- This product must not be used in locations exposed to the dangers of explosion.
- Make sure to install this product as shown in *Chapter 2, «Installation»* of this manual.
- When installing this product, make sure that you are only using genuine MOBOTIX parts and MOBOTIX connection cables.
- Make sure that you are installing this product on a solid surface that provides for a sturdy installation of the fixing elements used.

Electrical installation: Electrical systems and equipment may only be installed, modified and maintained by a qualified electrician or under the direction and supervision of a qualified electrician in accordance with the applicable electrical guidelines. Make sure to properly set up all electrical connections.

Electrical surges: MOBOTIX cameras are protected against the effects of small electrical surges by numerous measures. These measures, however, cannot prevent the camera from being damaged when stronger electrical surges occur. Special care should be taken when installing the camera outside of buildings to ensure proper protection against **lightning**, since this also protects the building and the whole network infrastructure.

Max. power consumption of attached extension modules: The power consumption of all attached **MxBus modules** must **not exceed 2.5 W**. When attaching modules to the MxBus connector **and** the USB connector, the **power consumption of all attached modules must not exceed 3 W, if the camera is powered by PoE class 3**. If **PoE class 2** is used, **the power consumption of all attached modules must not exceed 1 W!**

Never touch the lens: Due to the high performance of the D25M, the area of the image sensor **can get quite hot**, especially when the ambient temperature is also high. This does not affect the proper functioning of the camera in any way. For this reason, the product must not be installed within the reach of persons without the dome.

Power off before opening the camera: Make sure the power supply is disconnected before opening the camera (i.e., for installing or replacing sensor modules and SD cards).

Network security: MOBOTIX products include all of the necessary configuration options for operation in Ethernet networks in compliance with data protection laws. The operator is responsible for the data protection concept across the entire system. The basic settings required to prevent misuse can be configured in the software and are password-protected. This prevents unauthorized parties from accessing these settings.



FOREWORD

Dear MOBOTIX customer,

Congratulations on your decision to purchase an extraordinarily powerful and compact network camera "Made in Germany"! The D25M Dome is a complete decentralized system that has a high-performance processor, integrated software, an array of sensors and a digital SD card video recorder for long-term storage. The weatherproof MiniUSB and MxBus interfaces of the camera allow attaching MOBOTIX interface boxes and standard devices, such as 3G/UMTS modems, external storage devices, etc.

The numerous, easily interchangeable lens options of the D25M provide for solutions that can be tailored for many different application scenarios. This robust dome camera (IP65) can also be ordered with optional Vandalism, On-Wall and In-Ceiling sets.

The introduction of the newest five-megapixel sensor technology with increased light sensitivity not only generates more brilliant images with more details, it also delivers color images of higher quality under lowlight conditions. Another improvement – The D25M-IT now generates HD images (1280 x 720 pixels) instead of the VGA images of predecessor models (640 x 480 pixels).

Another plus – the improved light sensitivity of the 5MP sensors, which drastically reduces exposure times. In conjunction with MxLEO, the exposure and image optimization program working in the background, the camera generates perceptibly better and more detailed images especially under low-light conditions. This significantly reduces motion blur that is typical of longer exposure times with little light and thus provides much more image detail (faces, license plates, etc.) for proper identification.

You can download the MOBOTIX video management software **MxEasy** and **MxControlCenter** and the manuals from the MOBOTIX website: www.mobotix.com > **Support** > **Software Downloads**. For the iPad, iPhone and iPod touch iOS devices, MOBOTIX offers the MOBOTIX App, a free-of-charge mobile solution that is easily found when searching for "MOBOTIX AG" in the App Store.

If you have any questions, our support and international sales staff are available at intl-support@mobotix.com from Monday to Friday, 8 am to 6 pm (German time).

We would like to thank you for your trust and wish you all the best with your new MOBOTIX camera D25M Dome!





1 PRODUCT OVERVIEW

1.1 D25M Overview



1.1.1 General Product Characteristics

With the D25M series, MOBOTIX offers extremely compact, versatile and cost-effective mono dome cameras with up to 1,536 scan lines, an integrated video sensor and long-term internal storage on a MicroSD card (not available in the basic model). The basic model, the D25M Basic, is designed for indoor use, comes with a 82° Wide Angle lens and is powered over Ethernet (PoE).

Original MOBOTIX D25M image

Size comparison: standard resolution (analog) with 288 scan lines (CIF) versus a MOBOTIX resolution with 1,536 scan lines



A Master of Adaptability

All D25M models come with an easily interchangeable lens and a robust 1.5 mm thick polycarbonate dome. An extensive range of accessories is also available for installing the camera in an application-optimized manner, for supplying power or expanding the functions of the camera. Furthermore, MOBOTIX customers can take advantage of **MxEasy** or the professional control center software **MxControlCenter** free of charge and with an unlimited user and camera license. If required, a D25M camera can even be upgraded to function as a powerful intercom system by adding the MOBOTIX ExtIO module.

Robust and Elegant

The D25M is available in the Secure, IT or Basic models depending on the software features. Five high-performance lenses are currently available for the D25M in the compact M14 housing. Due to their low power consumption of only 3 watts, D25M cameras can operate in an extremely wide temperature range (-30 to +50°C/-22 to +122°F). Since MOBOTIX cameras neither fog up nor require heating, power can be supplied via the network cabling using standard PoE products. The D25M IT and Secure models are completely dust-proof and resistant to water jets (IP65; D25M Basic: IP54). The D25M Wall Mount makes the camera ideally suited for outdoor use and for installation over surface-mounted sockets so that the cabling remains thoroughly concealed.

Complete HiRes Video Solutions by MOBOTIX

As opposed to conventional solutions, MOBOTIX cameras with their decentralized approach offer so much more – state-of-the-art, network-based video security technology that increases operating efficiency and yields a high degree of every-day usefulness.



Extraordinary Picture Quality

Image quality is the one key criterion of a security camera. Due to their internal video analysis and data storage capabilities, the decentralized MOBOTIX systems are independent of the available network bandwidth. As a result, the system provides for efficiently storing and managing the video streams of a virtually unlimited number of cameras with the highest resolution at a reasonable cost.

5 Megapixel Image Sensors (5MP)

MOBOTIX cameras possess high-resolution image sensors with 5 megapixel resolution and excellent light sensitivity, which translates into more details when zooming and more clear-cut advantages for every user. By using the 5MP technology in their color and black&white image sensors, MOBOTIX cameras deliver convincing image quality and details even in bad weather and under lowlight conditions. Another important plus: thanks to its internal pre-processing of the image data, the camera can generate video streams with up to 30 frames per second.



MOBOTIX ExtIO
(functional extension for D25M)

QXGA Image Format: 2.5 Times More Detail Than Full HD

The 5MP sensor has a resolution of 2592 x 1944 pixels on both day and night sensors. While the image sensor shows its full strength when zooming the live image, the maximum image size per sensor has the more user-friendly QXGA format.

Low Light Conditions – No Problem

The maximum resolution of the color and black&white image sensors is 5 megapixels. The higher light sensitivity of the new color image sensors now allow using MOBOTIX color cameras around the clock even when the illumination is low.

MxLEO: Exposure Optimization and Reduced Image Noise

MxLEO – the MOBOTIX Lowlight Exposure Optimization – is an innovative technology that provides an entirely new experience in digital image optimization in all cameras running firmware 4.1.9 and higher. On the one hand, the improved light sensitivity of the MOBOTIX 5MP sensors drastically reduces exposure times. MxLEO, the exposure and image optimization program especially developed for these conditions, on the other hand, generates perceptibly better and more detailed images especially under low-light conditions below 25 Lux. Such conditions are typical at a parking lot at night that is illuminated by regular lights (approx. 10 to 25 Lux). Or in a building after hours, in which the emergency lights are burning (approx. 5 Lux). This significantly reduces motion blur that is typical of longer exposure times with little light and thus provides much more image detail (faces, license plates, etc.) for proper identification.

High-Resolution Sees More and Costs Less

One D25M camera equipped with a 82° Wide Angle lens is usually all that is required to monitor either an entire room from a corner or the four lanes of a gas station. The high degree of image detail not only reduces the number of required cameras, but also minimizes system costs by reducing the wiring complexity, emergency power requirements and number of recording devices required. D25M cameras (IT and Secure) feature direct recording to integrated MicroSD cards or external USB drives. As a result, these cameras can be used in standalone operation with zero network load!

One Camera For 4 Gas Pumps - Long-Term Recording Without Peripheral Devices



Universal Application from the Vacation Home to the Airport

MOBOTIX D25M cameras are suitable for use in large-scale facilities like airports given their unlimited scalability and high performance. However, they are equally suitable for use in small commercial or private buildings thanks to their integrated event, storage, alarm and telephony functions.

The Right Lens for Every Application

You can change the lens in the D25M camera models on site whenever necessary. Each lens is secured by a lock ring. Each camera has a factory-aligned and quality-tested lens, which makes on-site camera focusing unnecessary in most cases. The D25M cameras are available for delivery with a lens of your choosing or no lens at all.



The image area captured by the D25M varies depending on the selected lens. With a Super Wide Angle lens (L25 with 82°), for example, almost an entire room can be recorded from just one corner. With an L160 Telephoto lens, a D25M camera with a high-resolution

5 megapixel sensor is capable of clearly recording a license plate number from a distance of 75 meters. Or even the serial number of a 5 euro bill from a distance of two meters!



With a D25M equipped with an L25 lens, the (slightly) distorted image can be corrected by software

Virtual PTZ (vPTZ) – No Motor Required

The D25M can zoom in on detail as well. These vPTZ functions are a standard feature in the integrated D25M camera software. The image from the mono dome camera can be enlarged using e.g. the mouse wheel, a joystick or a software-controlled PTZ panel, and you can "move" the view to any section of the image. This provides the features of a mechanical PTZ camera without the disadvantages of maintenance and wear.



Quick and easy navigation with a USB joystick

Original D25M image with L25 lens (82°)

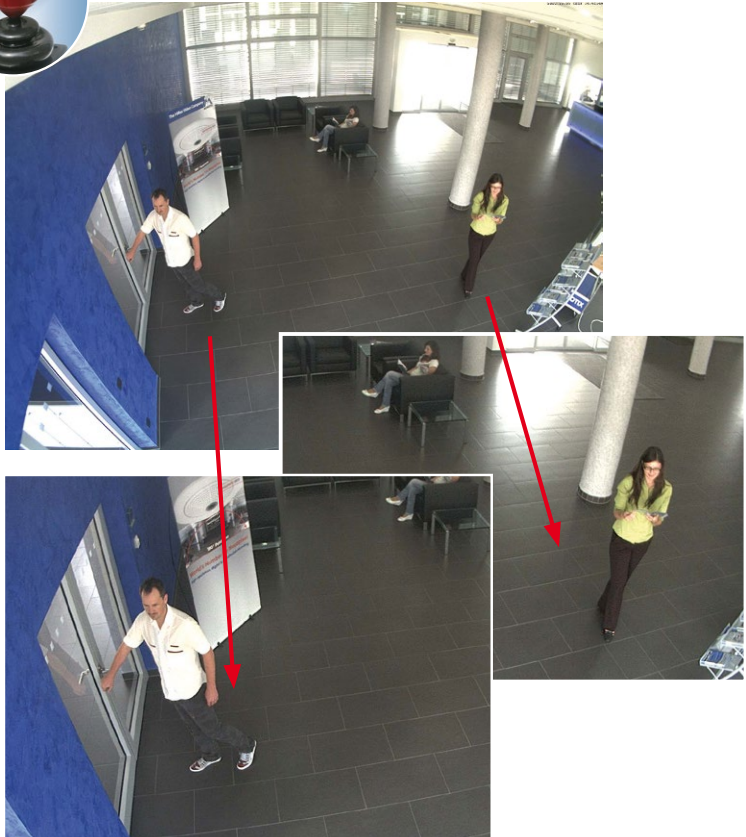

This vPTZ functionality works differently depending on the camera operation platform (**web browser, MxEasy, MxControlCenter**). Virtual zoom, pan and tilt using MxEasy and MxControlCenter is very simple thanks to special software tools and the use of an optional joystick. However, a joystick may also be used even with pure browser-based operation from Internet Explorer (together with an ActiveX plug-in).

Simultaneous Zoomed Live Image and Full Image Recording

All conventional, motorized PTZ cameras only store the image that is currently viewed as the live image (**live image recording**). This has one serious disadvantage as the recording can only show what has happened in the "visible" portion of the image; the rest is lost and cannot be examined later on. For this reason, MOBOTIX has added the new **full image recording** feature to the D25M. This will not store the currently viewed image that reflects the pan/tilt position and the zoom setting chosen by the user, but the full sensor image - without vPTZ settings. When examining the recorded images at a later point in time, the vPTZ features again come into play, as they allow the visible image to be zoomed and use the pan/tilt features to examine every corner of the recorded full image.

Example:

The people marked by the red circle in the middle area of the image would not have been recorded by a regular PTZ camera; the full image recording of the D25M allows you to determine, for example, the exact time at which these people entered the image area recorded by the camera. A **browser** (Internet Explorer with MxPEG ActiveX plug-in), **MxControlCenter** or **MxEasy** can be used to examine the recorded sequences.

Integrated vPTZ functions allow the complete stored full image to be "analyzed" at a later point in time (in MxEasy and MxControlCenter)

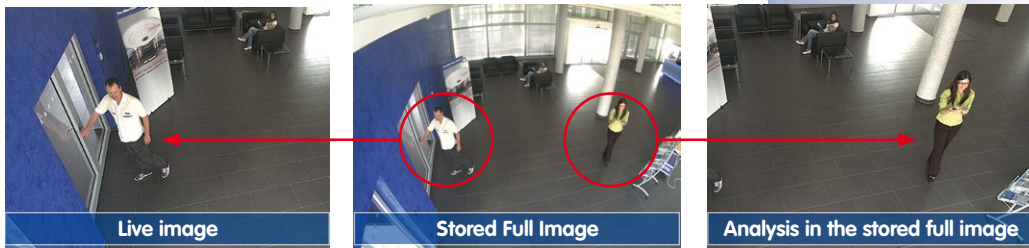

The image distortion caused by the L25 82° Wide Angle lens can be corrected. Since this function requires more computing power, it should not be enabled in the live image for applications that require a maximum frame rate. The image distortion in the recording can also be corrected at a later time.

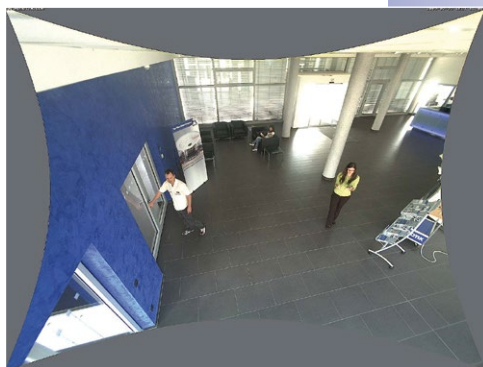

4 GB MicroSD card pre-installed in the camera (D25M IT/Secure)

Internal DVR

The D25M IT/Secure model features **direct recording to integrated MicroSD cards**, which makes the camera fully independent of any external storage media, even for longer periods of time. The camera internally stores high-resolution video, without requiring an external recording device or PC and therefore without overloading the network whatsoever. Old recordings may be overwritten automatically or automatically deleted after a specified period of time. A 16 GB MicroSD card, for example, allows the camera to store more than a quarter million event images in VGA format (640 x 480). For security reasons, the camera can even encrypt the stored data.



Power failures are not an issue, as the video and image sequences remain safely stored on the MicroSD card. Access to stored video sequences is possible at any time from the camera user interface in the browser, MxControlCenter or MxEasy. If you would like to archive sequences, you can store all of the data or only certain parts to a computer or a USB hard disk.

MxActivitySensor Video Motion Analysis: Secure Detection, Avoiding False Alarms

Regardless if there are large objects in the foreground or small objects in the background – MxActivitySensor will only trigger video recording and alarm messaging if something important is happening. Interference such as trees shaking in the wind, moving shadows and clouds and snow falling will no longer lead to false alarms. Since all of this is filtered automatically, all that remains is to set the direction of movement of objects that should trigger alarms.

Robust and Maintenance-Free

Thanks to their low power consumption of approximately 3 watts and the total absence of mechanical moving parts, the D25M models feature the highest operating temperature range from -30 to $+50^{\circ}\text{C}$ / -22 to $+122^{\circ}\text{F}$ and are completely dust-proof and resistant to water jets (D25M IT/Secure IP65; D25M Basic IP54). Since the cameras neither fog up nor require heating, power can be supplied all year round via the Ethernet cabling using standard PoE products.



D25M with the
In-Ceiling Set

Model Versions

The D25M is available in the **Secure, IT or Basic models**, which all come with different features. The D25M is delivered with an L25 Super Wide Angle lens (horizontal angle of 82°) as standard. Four additional lenses (Wide Angle and Telephoto) with viewing angles of 13°, 27°, 40° or 55° are available upon request. The standard IT and Secure models include a pre-formatted and pre-installed 4 GB MicroSD card. Audio features can be added at any time with the ExtIO module (not available for Basic model).

Basic and IT Cameras: Maximum Image Size Is Now HD Instead of VGA

The D25M-Basic and IT models now generate HD images (1280 x 720 pixels) instead of the VGA images of predecessor models (640 x 480 pixels). The special quality advantage of a MOBOTIX Basic/IT camera with HD resolution (1280 x 720): The HD images of a MOBOTIX are generated by the high-resolution image sensor with 2592 x 1944 pixels and are optimized and scaled down for the HD format. Because of the high-resolution sensor, the generated images – especially with respect to quality and light sensitivity – are noticeably superior than regular HD cameras that are only using a simple HD sensor with 1280 x 720 pixels.

1.1.2 Advantages and New Features

The high-resolution D25M Dome is a universally deployable, highly innovative and easily concealable camera system. A powerful successor to the D24M, the D25M features five-megapixel image sensors. For technical reasons, the live or recorded images displayed by an D25M sensor have a maximum size of QXGA. However, the D25M is clearly superior to the previous model in terms of image quality and frame rate.

Smooth HiRes Video Streams

The modified hardware of the D25M transmits the camera's video streams even more smoothly than the high-performance D24M, even when high resolution is required. Since image streams of 16 frames per second and higher are perceived as fluid video by the human eye, the maximum frame rate is limited to 30 frames per second (when using MEGA resolution of 1280 x 960) in order to provide sufficient camera processing power for other tasks.

Conclusive Still Images

Thanks to the proprietary MxPEG video codec developed exclusively for MOBOTIX cameras, the cameras offer the advantage that a recording can be paused at any given point and still provide meaningful and useful snapshots due to the absence of distortion. This is essential for security applications and allows individuals or license plates to be identified, for example. In contrast, the H.264 standard, which was developed for feature movies and is favored by some video security providers, cannot achieve this with the required level of quality.

Good Color Images Even in Low Light

The more light-sensitive an image sensor is, the better the image quality, especially when the ambient light level is low, such as at dusk and in heavy rainfall. The D25M offers the best MOBOTIX image quality that is currently available thanks to the light sensitivity provided by the five-megapixel color sensor that is four times higher than that of the previous three-megapixel color sensor and the new MxLEO exposure control.

More Details When Zooming

The maximum zoom factor of the D25M is 1.26 times higher than that of the S14 due to the use of five-megapixel technology. This means that the degree of detail provided by the camera has improved by 26 percent. As a result, an D25M can now be installed even further away than before from the objects and areas to be monitored. In addition, this relativizes the horizontal image angles of the new five-megapixel sensors that are slightly smaller compared to the D24M.

Black&White Image Sensor with 5 Megapixels

You can now order the D25M with a five-megapixel night sensor that can deliver black and white images with up to QXGA resolution. This results in larger images than those delivered by the previous 1.3-megapixel sensor with a perceptibly higher degree of details.

MxActivitySensor

The D25M provides an activity-controlled image analysis sensor as standard for detecting the movements of people and objects in a defined surveillance area (full image or section). The MxActivitySensor delivers reliable results particularly in outdoor area applications, in contrast to video motion detection that continues to be available and that registers all image changes in defined video motion windows. In the monitored area, the camera distinguishes between the continuous movements of vehicles, persons or objects that trigger an alarm and movements that do not set off an alarm such as shadows, changing light conditions and trees swaying in the wind.

Low Power Consumption in Accordance with the PoE Standard (IEEE 802.3af)

An D25M uses no more power than its predecessor (typically 4.5 watts), despite the new sensor technology. Adjusting the PoE class via the camera software also enables the use of PoE switches that cannot be operated on all ports with PoE class 3 (up to max. 12.95 V).



1.1.3 Decentralized Video System

Usually, cameras only supply images, while processing and recording take place later on a central PC using video management software. This centralized structure has too many limitations for high-resolution video systems since it requires high network bandwidth and the PC processing power is insufficient when using several high-resolution cameras. Due to the large number of computers and servers required, traditional centralized systems are therefore becoming less suitable and cost effective.

As part of the decentralized MOBOTIX concept, every camera features a **high-speed processor**, and, if necessary, digital **long-term flash memory** (MicroSD card) can be integrated to provide several days of recording time. The computer or video control center is required only to view and control the cameras, not to evaluate and record video. This means that you do not have to rely on expensive, overloaded video management software as most of the important functions that require a large amount of processing power are integrated into the MOBOTIX cameras themselves.

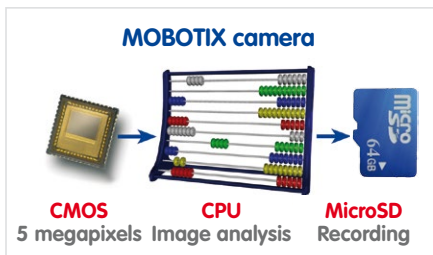

Integrated sensors enable MOBOTIX cameras such as the D25M to automatically detect when an event has occurred. If necessary, the cameras will respond immediately with an alarm sound and will establish a direct video and sound connection to a control room.

The D25M is equipped with a **shock detector** as standard (for all IT and Secure models). For example, if the camera receives a blow to the housing, it can simultaneously take a video of the offender, trigger a sound alarm and notify the security company by a SIP call. Due to the build quality and absence of moving parts, MOBOTIX cameras are extremely tough. This typically allows them to stay fully operational especially when they are subject to strong vibrations.

All MOBOTIX cameras are **backlight-proof** and are not adversely affected by the glare from direct sunlight. They deliver meaningful, detailed images at all times as the camera software supports easy programming of independent exposure windows, making them ideal for rooms with large glass fronts.

In the event of an alarm, MOBOTIX D25M cameras can also record lip-synchronous audio. The cameras therefore play an important role in analyzing and clarifying a situation. Thanks to an integrated speaker and microphone, each individual camera can also be used for bidirectional communication (two-way video communication), so you can easily use the MOBOTIX App with your iPhone or iPad on the road.

The decentralized **MOBOTIX video solutions** are superior to traditional systems in all major aspects. They are also considerably cheaper to operate since they require

- **Fewer cameras** due to the more accurate detail of panorama images with megapixel technology
- **Fewer recording devices** because in the decentralized system, ten times the standard number of cameras can be used to record high-resolution HDTV video with sound on one computer/server simultaneously
- **Lower network bandwidth** because everything is processed in the camera itself and the high-resolution images therefore do not have to be constantly transported for analysis



MOBOTIX System

Decentralized and Safe



Recording Software



Storage on Computer



1.1.4 Green IP Video

The modern, network-based video security technology offers numerous advantages to use energy efficiently. Due to the special product and system properties, the decision to install MOBOTIX video systems is also a decision for Green IP Video: low power consumption and environmental friendly because of long life expectancy and minimal amount of materials involved.

Low Power Consumption

MOBOTIX cameras are cost-efficiently supplied via PoE. This reduces the expenses for power and, in addition, saves copper and other important raw material as less power cabling is necessary.

Robust

MOBOTIX IP65 cameras are highly robust and work – without high-power climate control and extra protective housing – in a temperature range from -30 to $+50^{\circ}\text{C}/-22$ to $+122^{\circ}\text{F}$.

Modern

Integrated into the cameras are high-power processors and flash storage, thus making energy-consuming servers and storage devices unnecessary. And, of course, the disposal of waste later.

High Resolution

A hemispheric MOBOTIX camera with two image sensors replaces up to eight standard cameras – including their consumption of energy and resources.

Sustainable

Without mechanical components, MOBOTIX cameras are maintenance-free and stay fully functional, even after years – and are, thus, more sustainable compared to other systems.

Forward-Looking

Even previous camera models can be easily updated and then offer new functionalities. Remote updates via the internet and the fact that the cameras are maintenance-free reduce trips by car, and, thereby, the negative effect on the environment.

Notes

Lined area for taking notes, consisting of multiple horizontal dashed lines.

1.2 Technical Specifications

1.2.1 Lens Options, Hardware and Software Features





MOBOTIX currently offers five standard lenses with M14 thread from the L25 Super Wide Angle lens with a 22 mm focal length through to the L135 Telephoto lens with a 135 mm focal length (equivalent to 35 mm camera). Since MOBOTIX cameras are backlight-proof, they do not require a mechanical auto iris, making them extremely robust and maintenance-free.

- L25 Super Wide Angle with 82° image angle (horizontal)
- L38 Wide Angle with 55° image angle (horizontal)
- L51 Wide Angle with 40° image angle (horizontal)
- L76 Telephoto with 27° image angle (horizontal)
- L160 Telephoto with 13° image angle (horizontal)

The L25 Super Wide Angle 82° lens has very little distortion and delivers good image quality, even when using the maximum digital zoom. If a camera with this lens has been mounted in the corner of a room, the complete room is visible on the image.

Original image from a
D25M with 82° lens (L25)





Lens Table	L25	L38	L51	L76	L160
Original image					
35 mm equivalent focal length	25 mm (0.98 in)	38 mm (1.50 in)	51 mm (2.01 in)	76 mm (2.99 in)	160 mm (6.30 in)
Actual focal length	4 mm (0.16 in)	6 mm (0.24 in)	8 mm (0.31 in)	12 mm (0.47 in)	25 mm (0.98 in)
Aperture	2.0	2.0	2.0	2.0	2.5
Horizontal image angle	82°	55°	40°	27°	13°
Vertical image angle	61°	41°	30°	20°	10°
Distance 1 m (1.09 yd)					
Image width	1,7	1.0	0,7	0.5	0.2
Image height	1.2	0.7	0.5	0.4	0.2
Distance 5 m (5.47 yd)					
Image width	8.7	5.2	3.6	2.4	1.1
Image height	5.9	3.7	2.7	1.8	0.9
Distance 10 m (10.94 yd)	m	m	m	m	m
Image width	17.4	10.3	7.2	4.9	2.3
Image height	11.9	7.5	5.4	3.6	1.7
Distance 20 m (21.87 yd)					
Image width	34.7	20.6	14.5	9.7	4.6
Image height	23.7	14.9	10.8	7.2	3.4
Distance 50 m (54.68 yd)					
Image width	86.8	51.5	36.2	24.3	11.4
Image height	59.3	37.3	27.0	18.0	8.6

Notes

The specified focal lengths of the MOBOTIX lenses do not reflect the actual focal length of the lenses, but the focal length (Lxx mm) converted to 35 mm camera format. For example, the MOBOTIX L25 Super Wide-Angle lens has an actual focal length of 4 mm. This would be the equivalent of 25 mm on a 35 mm camera. It is therefore referred to as an L25.

Since the image sensors in digital cameras have different sizes, converting the focal lengths to 35 mm camera as a known format allows the image formats and the fields of vision of the different lenses to be calculated and compared more easily. Another benefit is that you can easily set a 35 mm camera (analog or digital) to the same focal length as the MOBOTIX lens (Lxx) to obtain the same field of vision. This approach greatly facilitates lens selection.

1.2.2 Camera Variants - Lenses, Hardware, Image Formats

Camera Model			
	D25M-Basic	D25M-IT	D25M-SEC
Lenses, Sensors			
Hemispheric 12 mm	–	–	–
Super Wide-Angle 25 mm	L25	L25	L25
Wide-Angle 38 mm	–	L38	L38
Wide-Angle 51 mm	–	L51	L51
Tele 76 mm	–	L76	L76
Tele 160 mm	–	L160	L160
CSVario 24 – 54 mm	–	–	–
Image sensor with individual exposure zones	Color	Color/BW	Color/BW
Sensor sensitivity in lux at 1/60 s and 1 s	0.25 / 0.013	0.25 / 0.013 (Color) 0.05 / 0.0025 (BW)	0.25 / 0.013 (Color) 0.05 / 0.0025 (BW)
Hardware Features			
IP protection class	IP54	IP65	IP65
Temp. Internal DVR (MB)	2	32	64
Internal DVR (MicroSD, up to 64 GB)	–	4 GB included	4 GB included
Microphone/speaker	–/–	–/–	–/–
Passive infrared sensor (PIR)	–	–	–
Integrated temperature sensor	•	•	•
Shock detector	–	•	•
Power consumption in Watts (typical)	< 4.5	< 4.5	< 4,5
Variable PoE class	2 – 3	2 – 3	2 – 3
Image Formats, Frame Rates and Image Storage			
Max. resolution (per sensor)	HD (1280x720)	HD (1280x720)	QXGA (2048x1536)
Max. frame rate (MxPEG, max. resolution)	30 fps	30 fps	20 fps
CIF images with 4 GB MicroSD DVR	–	250,000	250,000
VGA images with 4 GB MicroSD DVR	–	125,000	125,000
MEGA images with 4 GB MicroSD DVR	–	40,000	40,000
QXGA images with 4 GB MicroSD DVR	–	–	20,000

1.2.3 Camera Variants - Software Features

Camera Model			
	D25M-Basic	D25M-IT	D25M-SEC
General Features			
Digital zoom (continuous) with panning	•	•	•
Motion JPEG/MxPEG/H264 codecs	•/•/–	•/•/• (SIP video only)	•/•/• (SIP video only)
Programmable exposure ones	•	•	•
Snapshot rec. (pre-/post-alarm images)	3	10	50
Terabyte ring buffer storage (internal/network)	–	•	•
Continuous rec. with sound (0.2 to 30 fps)	–	•	•
Event recording with sound	–	•	•
Time and event control	•	•	•
Weekly schedules/holidays	–	•	•
Web functionality (FTP, email)	•	•	•
Playback/Quad- und MultiView	•	•	•
Bidirectional sound in browser	–	•	•
Logo generator, animated	–	•	•
Flexible event logic	–	–	•
Master/Slave arming	–	–	•
Several scheduled privacy zones	–	–	•
Customized voice messages	–	•	•
VoIP telephony (audio/video, alert)	–	•	•
Remote alarm notification (network msg.)	–	•	•
Signal inputs/outputs, RS232	–	Via MX-232-IO-Box	Via MX-232-IO-Box
Programming interface/HTTP API	–	•	•
Security features (HTTPS/SSL, IP-based access control, IEEE 802.1X network authentication)	•	•	•
Video Analysis			
Video Motion detector	–	•	•
MxAnalytics	–	–	–
MxActivitySensor	–	–	•
Video Management Software (free-of-charge from www.mobotix.com or App Store)			
MxEasy, MxCC	•	•	•
MOBOTIX App	•	•	•

1.2.4 Technical Data

Technical Data D25M	
Model variants	MX-D25M-Basic, MX-D25M-IT, MX-D25M-IT-Night, MX-D25M-SEC, MX-D25M-SEC-Night
Lens options	25 to 160 mm, horizontal angle 160° to 25°
Sensitivity	Color sensor: 0,25 lux at 1/60 s, 0,013 lux at 1 s Black and white sensor: 0,05 lux at 1/60 s, 0,0025 lux at 1/1 s
Image sensor	1/2,5" CMOS, 5 megapixels, progressive scan
Max. image resolution	Color/Black and White: 2048x1536 (QXGA)
Image formats	Selectable image formats, for example, 2048x1536 (MEGA), 1920x1080 (full HD), 1280x960 (MEGA), 1280x720 (HD), 1024x768, 800x600, 768x576 (D1-PAL), 704x576 (TV-PAL), 640x480, 384x288, 320x240, 160x120
Max. frame rate (M-JPEG) (live/recording)	VGA: 30 fps, MEGA: 10 fps, QXGA: 4 fps
Max. frame rate (MxPEG) (live and recording incl. sound)	VGA: 30 fps, MEGA: 30 fps, QXGA: 20 fps
Image compression	MxPEG, M-JPEG, JPEG, H.264 (SIP video only)
Internal DVR	MicroSD slot incl. 4 GB, max. 64 GB
External video ring buffer	Directly on NAS and computer/server without additional recording software
Software (included)	MxEasy video management software, MxControlCenter control center software, MOBOTIX App for iOS devices, iOS 5.0 and higher
Image processing	Backlight compensation, automatic white balance, image distortion correction, panorama correction, Video Motion detection, MxActivitySensor
Virtual PTZ	Digital pan/tilt/zoom, continuous 8X zoom
Alarm/events	Video Motion detection, MxActivitySensor, external signal, temperature sensor, PIR, microphone, shock detector, notification over e-mail, FTP, IP telephony (VoIP, SIP), visual/ acoustic alarm, pre- and post-alarm images
Mikrophone and speaker	Integrated microphone and speaker
Sound	Lip-synchronous audio, two-way communication, sound recording
Interfaces	10/100 Ethernet, MiniUSB, MxBus; inputs and outputs and RS232 via accessories
Video telephony	VoIP/SIP, two-way communication, remote controlling with key code, event notification
Security	User/group management, HTTPS/SSL, IP address filter, IEEE 802.1x, intrusion detection, digital image signature

Features are depending on the camera variant (see Section 1.2.3, «Camera Variants - Software Features»)

Technical Data D25M	
Certifications	EMV (EN 55022, CISPR 22, EN 55024, EN 61000-6-1/2, FCC Part15B, CFR 47, AS/NZS 3548)
Power supply	Ganzjährig Power over Ethernet (IEEE 802.3af); PoE-Klasse variabel, typ. 4,5 W
Operating conditions	IP65, -30 to +50°C/-22 to +122°F
Dimensions/weight D25M without mounting options	Diameter x H: 160 x 86 mm (on-wall installation); weight: approx. 350 g/0.77 lb (including lens)
Delivered parts	Housing (high-resistance composite, PBT), white, shock-proof polycarbonate dome transparent, free choice of lenses, mounting parts, allen wrench, patch cable, manual, software, 4 GB MicroSD card



1.3 Delivered Parts and Dimensions

1.3.1 D25M-IT/Secure



Item	Count	Part Name
1.1	1	Camera housing
1.2	1	Lens (pre-installed)
1.3	1	Lock ring (pre-installed)
1.4	1	Dome, transparent
1.5	1	Ethernet cable CAT5 0.5 m/20" (pre-installed)
1.6	1	Allen wrench 3 mm
1.7	1	Toothed wrench
1.8	1	Outer shell with rubber seal
1.9	1	Mounting ring
1.10	4	Dowels 8 mm
1.11	4	Stainless steel washers \varnothing 5.3 mm
1.12	4	Stainless steel wood screws with Torx head 4.5x60 mm
1.13	1	Torx wrench TX20
1.14	4	Stainless steel Allen screws M4x16 mm
1.15	4	Stainless steel washers \varnothing 4.3 mm
1.16	1	Single-wire plug, black (MxBus)
1.17	2	Single-wire connector
1.18	1	MxBus connector with two-wire connection line

Camera Housing and Connectors

The MOBOTIX D25M-IT/Secure consists of the camera housing (mainboard, lens, dome), the outer shell and the mounting ring.

Connections

- Network (Ethernet network incl. PoE power supply)
- MxBus for MOBOTIX expansion modules (e.g. MX-GPS-Box, MX-232-IO-Box)
- USB (e.g. for ExtIO, MX-232-IO-Box)
- Slot for MicroSD card

Outer shell

Dome

Lens

R key

L key

LEDs

Slot for MicroSD card

MxBus

USB

Network connector

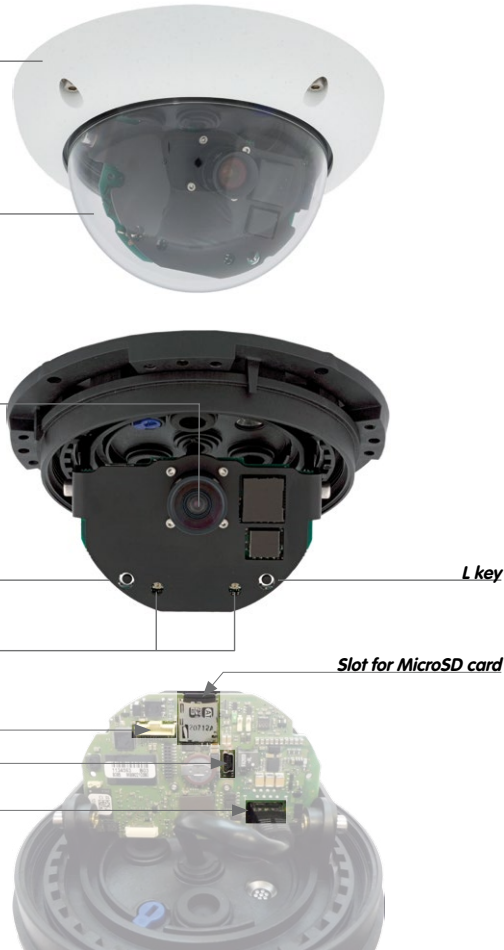

Dimensions

By rotating the camera module on both axes, you can aim the lens at the precise area you want to record.

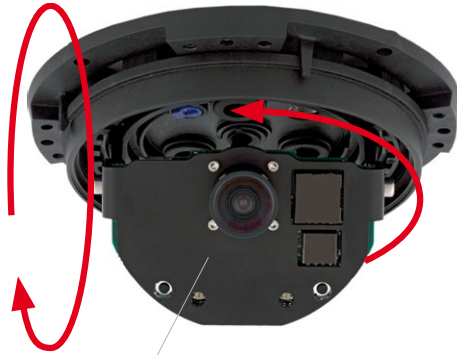

Camera module can be freely rotated and tilted



Drilling Template

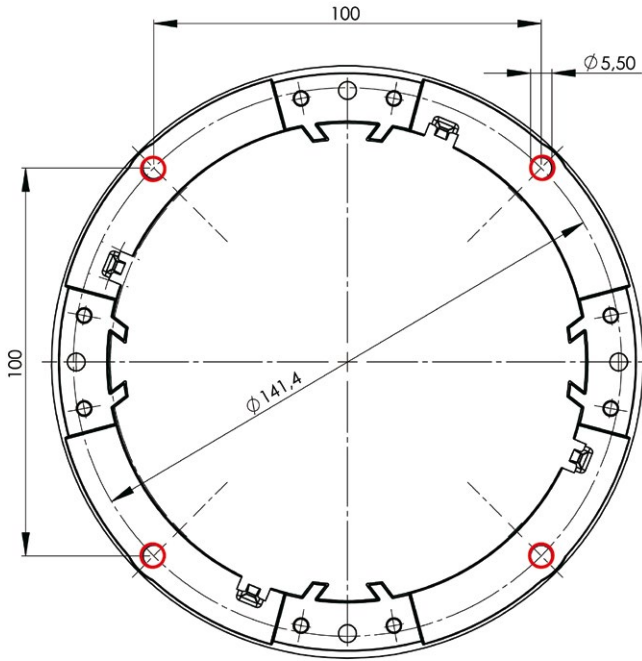

Find the drilling templates (scale 1:1) at the end of the manual as a fold-out

Notes

Use the folded drilling template at the end of the manual.

Make sure that the drilling template is not scaled or adjusted to the paper size when printing the PDF file (enlarged or reduced). When printing the PDF file, you should print two pages onto one using 100% scaling to obtain an unscaled printout of the drilling template.

1.3.2 D25M Basic



Item	Quantity	Part Name
2.1	1	Camera housing
2.2	1	Lens
2.3	1	Lock ring
2.4	1	Dome, transparent
2.5	1	CAT5 Ethernet cable, 0.5 m, pre-installed
2.6	1	Allen wrench 3 mm
2.7	1	Hook wrench
2.10	4	Universal screw anchors 8 mm
2.11	4	Stainless steel washers Ø 5.3 mm
2.12	4	Stainless steel Torx screws 4.5x60 mm
2.13	1	Torx wrench TX20
2.14	4	Allen screws M4x16 mm
2.15	4	Stainless steel washers Ø 4.3 mm

Camera Housing and Connector

The MOBOTIX D25M Basic consists of the camera housing with the motherboard, the lens and the dome.

Connections

- Network (Ethernet network incl. PoE supply)



Dimensions

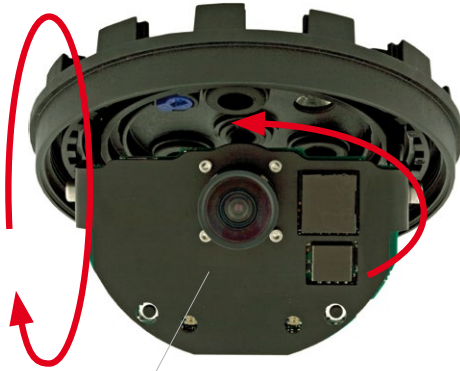

Camera module can be freely rotated and tilted

By rotating the camera module on both axes, you can aim the lens at the precise area you want to record.



Drilling Template

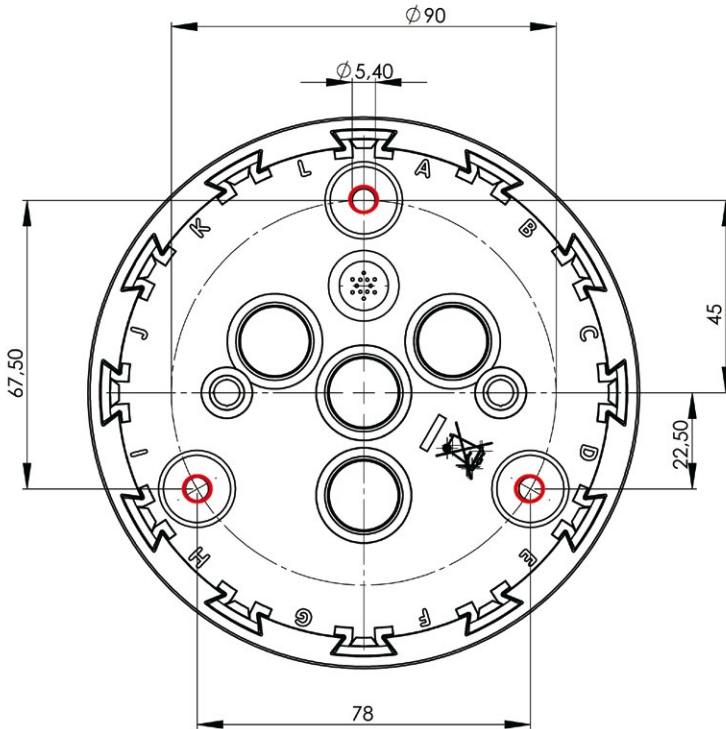

Find the drilling templates (scale 1:1) at the end of the manual as a fold-out

Notes

Use the folded drilling template at the end of the manual.

Make sure that the drilling template is not scaled or adjusted to the paper size when printing the PDF file (enlarged or reduced). When printing this page, make sure that you are printing at 100% scaling to obtain an unscaled printout of the drilling template.

1.4 Available Accessories

1.4.1 On-Wall Set

Order no.: MX-OPT-AP

Consists of On-Wall Mount and mounting supplies. Conforms to U.S. installation standards. Reliably protects the cabling and allows additional modules to be integrated within the On-Wall Mount (patch/installation cable connector, IO extensions, WLAN, battery, ...).



1.4.2 10° On-Wall Set

Order no.: MX-OPT-AP-10DEG

Consists of On-Wall Mount and mounting supplies for inclined installation (10°) of a camera. Conforms to U.S. installation standards. Reliably protects the cabling and allows additional modules to be integrated within the On-Wall Mount (patch/installation cable connector, IO extensions, WiFi, battery, ...).



1.4.3 Vandalism Set

Order no.: MX-D25M-Vandal

Consists of a stainless steel ring, security screws and reinforced dome (3 mm polycarbonate). Ideally suited for surveillance at critical locations.

In order for the camera to blend in better with its environment, the Vandalism Set is available in five different finishes: matt stainless steel, polished, white powder-coated, black powder-coated, silver-gray powder-coated.



1.4.4 In-Ceiling Set

Order no.: MX-OPT-IC

For simple installation in false ceiling tiles. Suitable for discreet surveillance. Optionally available with a stainless steel ring.



Also suitable for mounting to drywall

1.4.5 Outdoor Wall Mount

Order no.: MX-OPT-WH

Consists of Outdoor Wall Mount and mounting supplies. Covers RJ45 flush-mounted sockets. Space for expansion modules (battery, UMTS, WLAN, etc.). Easily mounted to poles using Pole Mount. Weatherproof IP65.



1.4.6 Corner and Pole Mount

Order no.: MX-OPT-MH

Flange for Outdoor Wall Mount. Can be mounted to wall corners or poles. 3 mm stainless steel, white. Wall Mount may be ordered separately or as a set.



1.4.7 Tinted Dome

Order no.: MX-D25M-OPT-DCS

Suitable for especially bright environments (e.g. under direct sunlight). A tinted dome reduces the glare from sunlight by 50% compared with the standard dome.



1.4.8 MiniUSB Cable to MiniUSB (Straight/Angled)

Order no.: MX-CBL-MU-EN-PG-STR-05/2/5 (straight/angled)

The MOBOTIX MX-232-IO-Box can be connected directly to the D25M with this cable, which is up to five meters long.



Only cables with angled plugs can be used for the D25M

Only cables with angled plugs can be used for the D25M

1.4.9 MiniUSB Cable to MiniUSB (Angled/Angled)

Order no.: MX-CBL-MU-EN-PG-EN-PG-05/2/5
(straight/angled)

The MOBOTIX ExtIO can be connected directly to the D25M with this cable, which is up to five meters long.



1.4.10 MiniUSB Cable to USB-A Socket

Order no.: MX-CBL-MU-EN-PG-AB-05/2/5

USB-based storage media (for example, USB hard drives) can be connected directly to the D25M with this cable, which is up to five meters long.



1.4.11 Ethernet Patch Cable for Bayonet Catch

Order no.: MX-OPT-CBL-LAN-1/2/5/10
(length: 1 m/2 m/5 m/10 m)

The MOBOTIX-developed special cable can be installed in a waterproof manner and has an integrated sealing gasket. Every D25M ships with a 0.5-m-long cable as standard, which can be exchanged for a patch cable up to 10 m in length.



1.4.12 NPA-PoE-Set

Order no.: MX-NPA-PoE-EU and MX-NPA-PoE-INT (Version EU and Version INT)
Order no.: MX-CBL-NPA-BAT-2 (battery cable for mobile voltage sources)

This is a multifunctional PoE injector according to the IEEE 802.3af standard – with three connectors (for network, camera/PoE device, PC), universal power supply unit with interchangeable adapter plugs and crossover function. The NPA-PoE-Set connects and remotely supplies a D25M with power via an Ethernet cable up to 100 m in length. The blue adapter can also be connected to mobile voltage sources from 12 to 57 V DC by means of an additionally available battery cable. The “EU” version of the NPA-PoE-Set is supplied as standard with a European adapter, while the “INT” version includes four adapters (EU, USA, UK, AUS).



Available Accessories

1.4.13 MX-Overvoltage-Protection-Box

Order no.: MX-Overvoltage-Protection-Box-RJ45

Order no.: MX-Overvoltage-Protection-Box-LSA

Weatherproof network connector (protection class IP65, -30 to $+60^{\circ}\text{C}/-22$ to $+140^{\circ}\text{F}$) **with surge protection of up to 4 kV for MOBOTIX IP cameras**, ideal for replacing the MX-Patch-Box.

At the same time, the MX-Overvoltage-Protection-Box provides a weatherproof connection of a camera's patch cable to a network patch cable (**-RJ45** variant) or a network installation cable (**-LSA** variant).



1.4.14 MX-NPA-Box

Order no.: MX-OPT-NPA1-EXT

The MX-NPA-Box is a weatherproof PoE injector conforming to the IEEE 802.3af standard and is designed to connect external voltage sources (12 to 57 V DC) to a MOBOTIX camera.

The MX-NPA-Box is equipped with the Patch-Box's weatherproof and extremely compact exterior housing (protection class IP65, -30 to $+60^{\circ}\text{C}/-22$ to $+140^{\circ}\text{F}$), which means it can also be installed in the space of the Outdoor Wall Mount. Interfaces of the MX-NPA-Box: Camera via patch cable, Ethernet via LSA+ and external power supply via terminal connector (12 to 57 V DC possible).



1.4.15 MX-GPS-Box

Order no.: MX-OPT-GPS1-EXT

The MX-GPS-Box primarily serves as a high-precision time source for systems without an Internet connection. In addition, it can provide triggering based on GPS events (reaching or moving away from a specified position; exceeding or not reaching a specified speed). This interface box can be attached to all MOBOTIX cameras with an MxBus interface.

The MX-GPS-Box is equipped with the same compact housing as the other interface boxes (protection class IP65, -30 to $+60^{\circ}\text{C}/-22$ to $+140^{\circ}\text{F}$). This interface box should not be installed inside of other wall mounts, but on the exterior of the building with a large section of open sky above it. This ensures the best possible reception from GPS satellites



and thereby the highest possible accuracy of the received GPS data. The maximum length of the MxBus wiring (0.8 mm diameter wires) is 50 m/55 yd.

1.4.16 MX-232-IO-Box

Order no.: MX-OPT-RS1-EXT

This box provides the signal inputs and outputs as well as the RS232 (serial) interface. It replaces the connections that were handled on the older camera models via a D-Sub 15-HD connector. The MX-232-IO-Box (protection class IP65, -30 to $+60^{\circ}\text{C}/-22$ to $+140^{\circ}\text{F}$) can be attached to all MOBOTIX cameras with an MxBus or USB interface. The maximum length of the MxBus wiring (0.8 mm diameter wires) is 50 m/55 yd. If the MiniUSB connector is used, the maximum cable length is 5 m/16 ft.



1.4.17 ExtIO Expansion Module

Order no.: MX-ExtIO

The device, which is suitable both for on-wall and in-wall installations, contains a powerful speaker, microphone, infrared motion sensor, ambient temperature sensor, two input and two output contacts and two illuminated keys. It is ideal for door communication, elevators, access control systems, etc. The ExtIO is suitable for use as direct connection to the S15 via a MiniUSB cable (max. 5 m), which can be ordered separately, or as a network connection via the PoE switch.



1.4.18 Mx2wire+ Media Converter

Order no.: MX-2wirePlus-Set-PW

The Mx2wire+ system allows an Ethernet network with PoE to be set up via two-wire cables, which saves users from having to lay several hundred meters of Ethernet cable. For example, an existing two-wire cable of an analog video camera can be reused to connect a high-resolution and modern IP network camera. Mx2wire+ is delivered in the standard wall outlet frame in different designs; however, it can also be used with the available on-wall socket that is included.



1.4.19 Other Accessories

Since the range of accessories for the MOBOTIX system keeps growing, you should visit the MOBOTIX website www.mobotix.com in the **Products > Accessories** section to see the entire list of available accessories.

THE MOBOTIX INFORMATION CHANNELS



Support on the MOBOTIX Website

www.mobotix.com/other/Support



The MOBOTIX Video Tutorials

www.mobotix.com/other/Support/Tutorials



Seminars on MOBOTIX Campus

www.mobotix.com/other/Partners/Seminars



The MOBOTIX YouTube Channel

www.youtube.com/MOBOTIXAG

1.5 MOBOTIX Software

1.5.1 Integrated Camera Software (Firmware)

MOBOTIX cameras and connected MxBus modules operate with built-in firmware whose functions are accessed by the MOBOTIX **MxControlCenter**, **MxEasy** remote stations and **MOBOTIX App**.

The D25M models therefore also feature a variety of functions that are integrated in the firmware: from motion detection and long-term storage right through to alarm notification via video IP telephony. The virtual PTZ functions allow you to continuously zoom into or out of a MOBOTIX camera image using either the mouse wheel or a joystick.

When recording image or video sequences, you can choose to store either the section of the live image that is visible or the full sensor image (full image storage). This also allows you to examine parts of an image or video that had not been visible in the live image section on display at the time of the recording.

Unlike in the camera systems from other manufacturers, there is no need to buy an install additional software on your computer thanks to the MOBOTIX firmware that can be accessed directly in a web browser via the camera IP address. Instead of using a web browser, you can also download the free MxControlCenter or MxEasy video management software from the MOBOTIX website (www.mobotix.com > **Support**) to quickly display multiple cameras on one monitor or on an entire video wall, switch alarms with sound or conveniently search for an event. The **MOBOTIX App** for iOS devices (iPhone, iPad, iPod mini, iPod touch, iOS version 5.0 and higher) is also available free of charge from the **App Store** for your mobile applications.

Download free of charge
from www.mobotix.com

No license fees!
Free updates!



1.5.2 MxControlCenter

The MxControlCenter video management software can be used to combine any number of cameras at any locations into a well-structured and powerful video security system with centralized or local access-protected operation and analysis.

The state-of-the-art software, specifically tailored to support high-resolution MOBOTIX network cameras, provides a user-friendly user interface and camera image display, convenient video search functions, effective alarm handling, automatic camera integration, video storage on file servers as well as useful configuration and update wizards.

MxControlCenter –Professional Video Management

- Proven worldwide in the most demanding video applications thousands of times over
- Unlimited number of users and cameras
- No license fees
- Individual user interface, adaptable to each individual user
- Simplest installation and complete use on any standard PC
- Convenient layout editor for integrating real building plans
- Integration of conventional network and analog cameras as well
- For Microsoft Windows



Several hundred cameras can be managed on a standard computer

Download free of charge from www.mobotix.com

No license fees!
Free updates!



1.5.3 MxEasy

MxEasy makes it simple to operate the most important functions of the camera thanks to its intuitive user interface and represents a new approach to viewing and controlling MOBOTIX cameras. The clear design allows you to manage up to 16 cameras, and the application can show up to four cameras at the same time.

All settings selected in MxEasy (for example, virtual camera position, zoom, brightness, volume, microphone sensitivity, image storage, signal outputs) can be used immediately and are stored instantly in the configuration of the corresponding camera. The calendar functions integrated in the Alarm Planner provide an innovative tool for the scheduled settings of one or more cameras. This tool not only controls video and sound recording based on certain time and date information, but also allows features like video motion detection, image brightness and the microphone to be activated/deactivated based on a date and time schedule.

MxEasy – Simple Operation of the Most Important Camera Functions

- Cameras can be installed without any knowledge of networks
- Supports up to 16 MOBOTIX cameras
- Time- or event-controlled recording
- Time-controlled motion detection, image brightness and microphone
- For Microsoft Windows and Mac OS X

Suitable for up to 16
MOBOTIX cameras

Download free of charge
from www.mobotix.com

No license fees
Free updates



1.5.4 MOBOTIX App

Premium solution: There for you whenever and wherever you need it, the MOBOTIX App serves as the perfect remote mobile station that uses intelligent detailed solutions to increase security and convenience for users on a daily basis. The controls are optimized for use with touchscreen devices and feature three main views (Live, Player, Events), self-explanatory symbols, large software buttons, multifunctional sliders developed by MOBOTIX as well as simple gestures like swipe and tap, making it easy for newcomers and older users to work with professional security equipment. In addition, using mobile devices to operate the various functions such as door opening, activating the voice mailbox, switching the door bell off at night and switching a light on/off, creates added value in the form of greater convenience and security in every day life.

MOBOTIX App – Mobile Remote Station for MOBOTIX Cameras and Door Stations

- Bandwidth-optimized remote access via WLAN (WiFi) or the Internet
- Live images and recordings in the best MOBOTIX HiRes quality
- Two-way communication, door opening and video mailbox access
- Doorbell and alarm notifications, protection of privacy
- Convenient search functions, playback of external MxPEG videos
- Grouping of cameras and filtering of events
- Free from the **App Store** for the iPad, iPad mini, iPhone and iPod touch



Free download from the **App Store**

No license fees
Free updates



2 INSTALLATION

Although the D25M is primarily designed for installation on walls and ceilings, it can also be mounted to a pole or the corner of a building, for example, using the appropriate MOBOTIX accessories.

2.1 Preparing the Installation

Before installing the MOBOTIX D25M, the following questions should be answered:

1. **Where will the camera be mounted?**
Mounting to a ceiling or wall, see *Section 2.1.1*
2. **Which other mounting options are available?**
On-wall mounting, in-ceiling mounting, vandalism protection, wall mounting, pole mounting, see *Section 2.1.2*
3. **How is the camera connected to the network and how is the power supplied?**
MX-NPA-PoE or other PoE components (IEEE 802.3af), see *Section 2.1.3*
4. **How are the connections furnished from the building?**
Sockets, see *Section 2.1.4*
5. **What cabling considerations are necessary?**
Wiring, see *Section 2.1.5*

The following sections contain a brief answer to each of these questions, as well as references to the relevant sections in this manual. For more information on the MOBOTIX D25M and available accessories, please see: www.mobotix.com.



2.1.1 Ceiling and Wall Mounting

Like all MOBOTIX cameras, the D25M is extremely flexible in terms of how and where it can be installed (see *Section 2.1.2*). The Basic model meets the IP54 standard while the IT and Secure models are weatherproof in accordance with IP65. However, installations on a wall or ceiling are the most common mounting positions. In indoor spaces, the D25M is usually mounted from the ceiling. The Super Wide Angle lens (82°, L25) allows a room to be monitored almost entirely by a camera mounted in the corner. Using the PTZ software, you can easily zoom in on image details in either the live image or the recording.

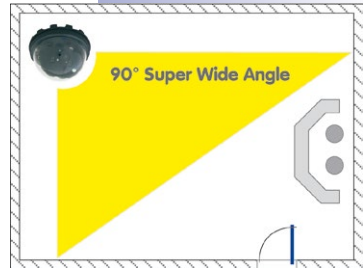

Ceiling Installation with the In-Ceiling Set



Wall Installation Using the Outdoor Wall Mount

Outdoors, the D25M is usually mounted on a building wall. In principle, the camera can be installed without additional wall mounts, although the positional range of the lens may be limited as a result. **We therefore recommend using the practical Wall Mount from the range of available accessories** (see *Section 2.6*). The cable exit of the D25M is located in the center of the housing's underside. For more detailed information on the installation process, see *Section 2.2* and the following sections. The appropriate drilling templates can be found at the end of the manual.



One Camera For 4 Gas Pumps - Long-Term Recording Without Peripheral Devices



2.1.2 Mounting Options

On-Wall Installation (MX-OPT-AP)

The On-Wall Set can reliably protect external cables if the cables cannot be fed in the center below the camera housing. The On-Wall Mount also provides ample space for extra modules.



On-Wall Set (IP65, for outdoor applications)

On-Wall Installation with 10° Inclination (MX-OPT-AP-10DEG)

This On-Wall Set is identical to the regular On-Wall Set, except that the mounted camera is inclined by 10 degrees. The inclination makes it possible for the camera to deliver the best images even in demanding situations.



10° On-Wall Set (IP65, for outdoor applications)

In-Ceiling Installation (MX-OPT-IC)

The In-Ceiling Set allows the D25M camera to be installed in suspended ceilings, for example. This type of installation provides optimal protection for the camera and reduces the visible profile to a minimum since only the dome remains visible.



Discreet in-ceiling installation; decorative outer ring also available in stainless steel

Vandalism Set (MX-D25M-Vandal)

The Vandalism Set provides added protection for D25M cameras. The set consists of a robust stainless steel cover (matt or polished) and an impact-resistant polycarbonate dome. A camera equipped with the Vandalism Set is perfectly suited for applications in demanding environments (such as prisons, trouble areas, train stations, etc.).



Vandalism Set (IP65)

Wall Mount (MX-OPT-WH)

The Wall Mount is the ideal solution for mounting the D25M to walls for indoor and outdoor applications. The camera is completely dust-proof and resistant to water jets (IP65). The Wall Mount also covers RJ45 flush-mounted sockets and has ample space for additional modules.



Wall Mount made from sturdy PBT-30GF (IP65)

Corner and Pole Mount (MX-OPT-MH)

The MOBOTIX Corner and Pole Mount is the ideal choice when mounting the MOBOTIX D25M to a pole or building corner. This mount can only be used in conjunction with the Wall Mount. For poles with a diameter ranging from 60 to 180 mm.



Outdoor Corner and Pole Mount made from stainless steel (in conjunction with Wall Mount)

The D25M supports the Power over Ethernet standard IEEE 802.3af (PoE)

The Network Power Adapter replaces the crossover cable when directly connecting to a computer



2.1.3 Network Connection and Power Supply, UPS

Power Over Ethernet (PoE Conforming To IEEE 802.3af)

All D25M models are supplied with power using the PoE standard. The Network Power Adapter (MX-NPA-PoE) may be used for smaller installations. For larger installations, it is worth investing in a PoE-capable supply device D25M available on the market (PoE switch/router).

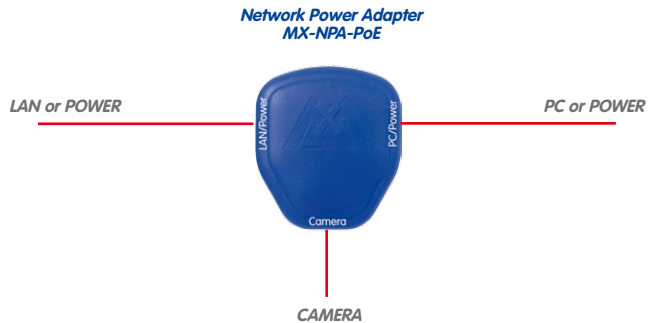

The **maximum length** of the network cable for power supply over an Ethernet cable is **100 m**. The Mx2wire+ media converter set (available as an accessory) can be used to extend the range of an Ethernet connection up to 500 m in length (maximum transmission speed for a 500-m cable: 45 Mbps and 12 W for the PoE device).

Note

The MOBOTIX D25M can be powered by switches or routers which support the PoE (Power-over-Ethernet) standard and conform to IEEE 802.3af.

Advantages of PoE power supply:

- Allows setting up centralized backup power supply via the network.
- Reduces energy consumption.
- No extra network connection for camera required.

Using Uninterruptible Power Supplies (UPS)

You should install an uninterruptible power supply (UPS) in order to maintain a continuous power supply even when utility power fails. These devices also provide full protection against electrical surges and voltage fluctuations, enhancing the reliability of the system as a whole.

When using a more powerful 19" rack-mounted UPS, you can also protect all other network components (for example, switches, routers, PoE switches, etc.).

Since MOBOTIX cameras do not require any heating, even during winter, the average power consumption of less than 5 watts is very low. This, in turn, means that you can centralize the UPS-protected power supply by injecting power into the Ethernet cables (max. 100 m). This kind of protected power supply can be used either with MOBOTIX PoE products (MX-NPA-PoE + Universal Power Supply) or with PoE-compliant switches according to IEEE 802.3af.



2.1.4 Preparing the Camera Connections, MX-Overvoltage-Protection-Box

Once the camera position, the position of the cable outlets and the method of power supply have been decided upon, the cabling can be installed. Before installing the MOBOTIX D25M, you should make sure that the network connections have been properly tested so that the proper functioning of the camera is guaranteed.

If the camera is to be installed outdoors, you should also install the MOBOTIX MX-Overvoltage-Protection-Box (optional accessory). This interface box not only provides **overvoltage protection of up to 4 kV for MOBOTIX IP cameras**, it also provides simple and weatherproof connection of the cameras to a network patch cable (-RJ45 variant) or a network installation cable (-LSA variant).

For additional information on the MX-Overvoltage-Protection-Box, open the **Products > Accessories > Interface Boxes** section on www.mobotix.com.

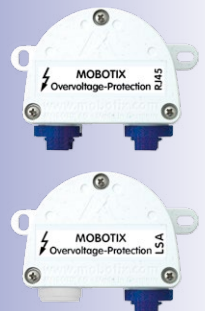

UPS units not only protect the camera against power failures, they also protect all other connected network devices against damage from voltage peaks and lows

2.1.5 Wiring, Fire Prevention, Lightning and Surge Protection

When installing the wiring inside or outside of buildings, make sure you always adhere to the relevant regulations on wiring, fire prevention and protection against lightning.

MOBOTIX cameras are protected against the effects of small electrical surges by a range of measures. These measures, however, cannot prevent the camera from being damaged when stronger electrical surges occur. Particular care should be taken when installing the camera outside to ensure proper **protection against lightning**, as this also protects the building and the entire network infrastructure.

MOBOTIX recommends having MOBOTIX cameras installed only by certified specialists accustomed to installing network devices and having proper respect for the applicable regulations regarding lightning protection and fire prevention as well as the current technology for preventing damages from electrical surges.

Guidelines for Wiring

- **Data cable:** Make sure you only use double-shielded CAT5 or higher cable (**S/STP**) for Ethernet connections.
- **Outdoors:** Installing the camera outdoors requires special precautions and measures regarding the cables as well as lightning and surge protection (see below).
- **Wire lengths:** The cable segments must not exceed the maximum allowed cable lengths in order to ensure proper data transfer (see *Section 2.9*).
- **Avoiding induction:** When running data cables parallel to existing regular power lines or high-voltage wires, make sure you observe the minimum distances to the power cables.



Fire Prevention

When installing the power lines to the camera, make sure you always adhere to the country-specific regulations (e.g. VDE in Germany, IEEE in the USA) in effect on wiring and fire prevention at the site of the installation.

Lightning and Surge Protection

In order to avoid damage to MOBOTIX cameras from overvoltages, you should always install the MX-Overvoltage-Protection-Box. This competitively priced and weatherproof network connector provides reliable protection against overvoltages of up to 4 kV; the box is easily installed in the Outdoor Wall Mount, for example (see *Section 1.4.13, «MX-Overvoltage-Protection-Box»*).

More information is available at an institution such as the International Electrotechnical Commission (IEC, www.iec.ch) or at a manufacturer of protection devices against lightning and electrical surges, such as Dehn (www.dehn.de).

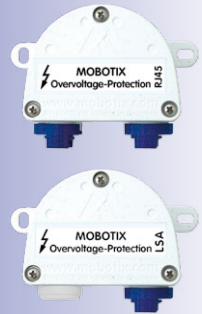

2.2 Mounting the Camera Without Accessories



2.2.1 Mounting Instructions

As an allround camera, the D25M is primarily designed for installation on walls or ceilings. In general, direct installation of the camera without any accessories is always possible. However, to ensure a flush finish with the surface, you should first install a flush-mounted wall outlet (space for the connection cable).

If you choose to mount the camera directly to a wall without the MOBOTIX-recommended wall mount, you should position the camera in the center of the room to guarantee maximum coverage.

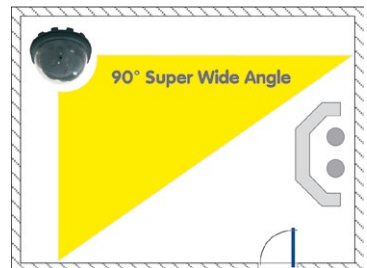
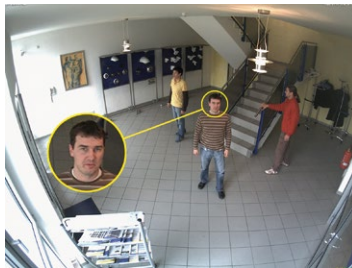

Required Tools

Please first check that all the components supplied with the camera are present in the original packaging. You will need these additional tools for installing:

- Any additional materials for fastening the camera to a ceiling/wall, if necessary – **4 Torx screws incl. screw anchors and washers** are included in the original packaging.
- **Screwdriver**
- **Power drill** for screw anchor holes needed for ceiling/wall mounting
- **MOBOTIX drilling templates** (at the end of this manual)
- **Scissors** to cut out the template
- **Pen** to mark the drill holes
- Materials and any tools needed to connect the pre-installed MOBOTIX network cable in the camera with the on-site network cable.



2.2.2 Procedure for All D25M Cameras

Install the camera using the following procedure:

1. Install and prepare **the network connection**.
2. **Drill the holes:** Please use the enclosed screws and screw anchors whenever possible. It is essential that you use the supplied drilling template to ensure the precise alignment of holes for either the mounting ring of the D25M IT/Secure or the camera base of the D25M Basic (fold-out at the end of this manual).
3. **Hollow out background surface** for the cable and connector or insert the cable behind the suspended ceiling or cable duct.
4. **Connect** the pre-installed network cable of the camera to the installation cable (adapter not included in delivery).
5. **Attach** the camera to the ceiling or wall (see sections below).
6. **Aim and adjust the lens** (see *Section 3.3.1*).

Caution

For safety reasons, only use the pre-installed MOBOTIX network cable that was included in the delivery. Always ensure that the rubber plug of the network cable reliably protects the outer shell from moisture entering the camera. All openings of the camera housing need to be properly sealed. This is the only way to guarantee that the camera remains weatherproof.

Notes

Network Connection Without Pre-Installed Cable

The network cable is fed through the ceiling directly above the camera. Make sure the cable is completely sealed by the rubber gasket on the housing (do not bend the cable!) When preparing the installation, ensure that at least 15 cm of cable length (excluding the connector itself) remains inside the camera housing (similar to factory preinstallation). This will ensure that you can turn and tilt the lens mount freely later on.

Surface-Mounted Socket

If a surface-mounted socket is used, the camera must be mounted using the outdoor Wall Mount. The camera cannot be mounted directly on top of protruding, surface-mounted sockets.

2.2.3 Procedure for D25M IT/Secure



1. Install and prepare **the network connection**
2. **Install the flush-mounted socket:** The pre-installed cable attached to the camera must be connected with the on-site network cable. For installation without accessories, a flush-mounted socket must be installed first to provide space for the connection. The cabling is now perfectly protected and cannot be seen or accessed from the outside. The camera cannot be mounted directly on top of protruding, surface-mounted sockets. Use the supplied camera drilling template (fold-out at the end of this manual) to mark the position of the flush-mounted socket for the desired camera position.
3. **Drill the holes:** Drill the holes for the supplied screw anchors (see drilling template).
4. **Connect the cable:** Connect the on-site network cable to the camera patch cable using a standard connector.
5. **Attach the camera:** Use the (included) screws to affix the mounting ring and the camera at the designated position.
6. The outer shell is required at a later stage in the installation and is attached only when the dome has been removed and placed back after a lens adjustment.
7. Proceed to *Section 3.3.1, «Aiming and Adjusting the Lens».*

2.2.4 Procedure for D25M Basic



1. Unscrew the **transparent dome** of the camera in a **counter-clockwise** direction. To keep the dome clean, use the enclosed plastic foil or a lint-free cotton cloth.



2. **Unplug the pre-installed network cable** from the network connector inside the camera. Never touch electronic components as the static electricity may damage them!



3. **Loosen the internal part of the camera** by releasing the two blue clamps with the thin side of the hook wrench.



Now turn the toothed ring in a counter-clockwise direction using the other side of the hook wrench.



4. **Remove the internal part of the camera** with the lens mount from the base of the camera.



5. **Position the base of the camera housing over the drilled holes** and the prepared cable exit. Please make sure that the camera base is relatively flush with the surface. The network cable with connector should be flush with the ceiling or wall as a result. Since the three holes for the screws in the outer shell are factory sealed, they must be broken open, for example, using a 5 mm drill bit.



6. **Tighten the base of the camera using the supplied screws.** Depending on the installation site, the screw openings should be sealed shut (e.g. with silicon).

7. **Insert the internal part of the camera with the lens mount into the attached outer shell** and secure it by turning the two blue clamps in a clockwise direction using the supplied hook wrench or a screwdriver. This will prevent the internal part of the camera from falling out before it has been tightened into place.



8. Now secure the internal part of the camera by turning the toothed ring in a clockwise direction until you can still turn the internal part of the camera without much force.



9. **Connect the network cable** to the network connector of the camera.



10. Proceed to *Section 3.3.1, «Aiming and Adjusting the Lens».*

2.3 Mounting the Camera with the On-Wall Set



2.3.1 Mounting Instructions

On-Wall Sets available in 0° and 10° inclinations allow the D25M to be installed quickly and easily on the wall or ceiling of a room. When using the set outdoors (IP65), ensure that the screw holes on the rear of the camera housing are sealed with the included foam rubber washers. It is not possible to install the On-Wall Set directly above a surface- or flush-mounted socket.

The 10° On-Wall Set is the right choice if you want to mount the D25M on a wall with the lens pointing vertically downward (90° or more). If the 10° On-Wall Set is not used, then the angle of the lens may not exceed 80° for design-related reasons.

If the discreet appearance of the D25M is of particular importance, the In-Ceiling Set is ideal for mounting the camera on ceilings or drywalls.

The network connection and drill holes must be prepared correctly before installing the On-Wall Set (both indoors and outdoors):

- **Network connection:** You can use any one of the four openings in the On-Wall Set to guide the cabling into the camera. The network cable must be fed through the opening without a connector. An additional connector to connect to the camera cable is required.
- **Preparing the drill holes:** Use the supplied drilling template for the D25M On-Wall Set (fold-out at the end of this manual) to mark the exact position for drilling the anchor holes with regard to the camera position.

Caution

When using the On-Wall Set outdoors, ensure that the screw holes on the rear of the camera housing are sealed with the foam rubber washers included in delivery (IP65).

Drilling Template On-Wall Set

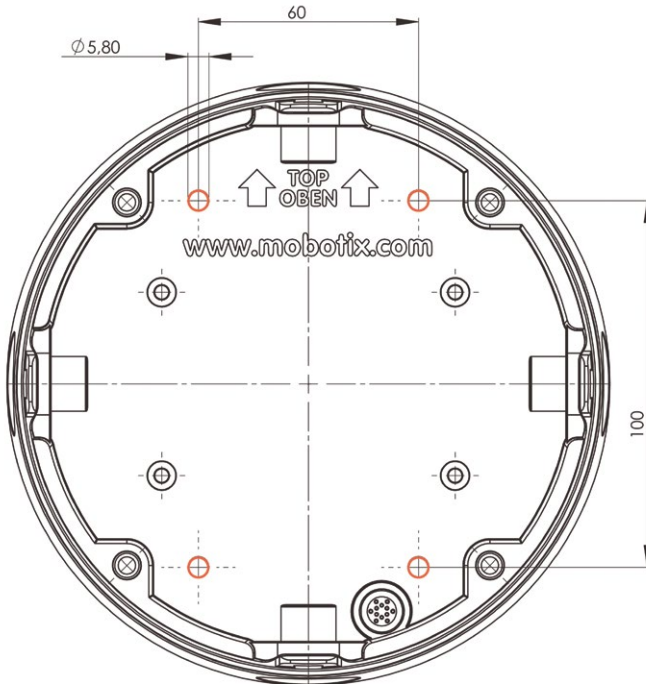

Find the drilling templates (scale 1:1) at the end of the manual as a fold-out



0°-Set: 160 mm



10°-Set: 166 mm

Notes

Use the fold-out template included at the end of the printed manual (valid for both 0° and 10° On-Wall Sets).

Make sure that the drilling template is not scaled or adjusted to the paper size when printing the PDF file (enlarged or reduced).

The maximum torque for all screws is 1 to 1.2 Nm.

Required Parts

Please first check that all components supplied with the On-Wall Set are present in the original packaging. The following additional items are required for installation:

- Suitable materials for ceiling/wall installation: **4 screws incl. screw anchors and washers** (e.g. from the original camera packaging)
- **Screwdriver**
- **Power drill** for screw anchor holes needed for ceiling/wall mounting
- **MOBOTIX drilling templates** (at the end of this manual)
- **Scissors** to cut out the template
- **Pen** to mark the drill holes
- Materials and tools needed to connect the pre-installed MOBOTIX network cable in the camera with the on-site network cable



2.3.2 Procedure

1. **Attach washers:** Prior to installation, stick a black foam rubber washer around each of the four screw holes on the rear side of the on-wall housing (remove the adhesive foil and press into place, surface must be clean and free of grease). This prevents water from entering the housing.
2. **Prepare the cabling:** Insert the seal into the cable opening of the On-Wall Set such that the black rubber seal is on the outside. Fix it in place from the inside using a small hexagonal nut.
3. **Mount the On-Wall Set:** Mount the On-Wall Set (without the camera) at the intended position using the Torx screws (included with D25M camera, items 1.10 – 1.12).
4. **Cable feeding:** Attach the counter nut to the network cable, pass it through the seal from the outside and tighten the nut. The network cable is now screwed into the On-Wall Set, weatherproof. All unused openings must be sealed with the included sealant plugs. The cable passing into the housing must always be installed using the supplied three-part fittings.
5. **Remove the camera outer shell:** Remove all four Allen screws with the supplied Allen wrench and lift off the outer shell (not mounted upon delivery).

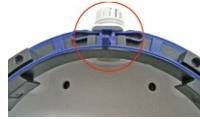

6. **Remove the mounting ring:** Separate the black mounting ring from the camera housing (lift the spring clip). This ring is not required when mounting the camera to the On-Wall Set.



7. **Connect the cable:** Connect the on-site network cable to the network cable passing through the On-Wall Set using a standard connector. Make sure to leave enough unused cable inside the housing. This will ensure that you can turn and tilt the lens mount freely later on. Excess cable can be easily stored within the On-Wall Mount.



8. **Attach the camera to the mount:** Press the D25M so that it is seated firmly within the On-Wall Mount. The tapered guides at the back of the D25M housing fit exactly into the openings of the On-Wall Mount. Attach the white outer shell with the supplied Allen screws (without rubber seal) once the lens has been adjusted.



9. Proceed to *Section 3.3.1, «Aiming and Adjusting the Lens».*

2.4 Mounting the Camera with the In-Ceiling Set



The white decorative ring is also available in stainless steel

2.4.1 Mounting Instructions

The In-Ceiling Set offers the most stylish installation option for the D25M. When properly installed, the only visible component is a particularly sleek and discreet dome camera, while most of the remaining components are concealed inside the ceiling. Only the compact dome and the thin decorative ring that conceals the screws can be seen.

For these reasons, the D25M installed with the In-Ceiling Set is the preferred option for most indoor spaces frequented by customers or the general public (e.g. hotels, restaurants, banks, retail stores, public buildings, etc.).

The common use of suspended ceilings in commercial and public buildings is an additional reason to place a preference on in-ceiling installation. The installation process is also simplified, as the network cable may be laid without difficulty and only a 15 cm diameter hole must be cut in the ceiling or ceiling component.

Before installing the MOBOTIX D25M (IT/Secure) on an indoor ceiling with the In-Ceiling Set, you must prepare the network connection and drill a hole for the camera:

- **Network connection:** The network cable is fed through the ceiling directly above the camera. When preparing the installation, make sure that about 15 cm of cable remains unused.
- **Cut a hole for installation:** The hole should have a **diameter of 150 mm** (see drilling template at the end of the manual).

Drilling Template In-Ceiling Set

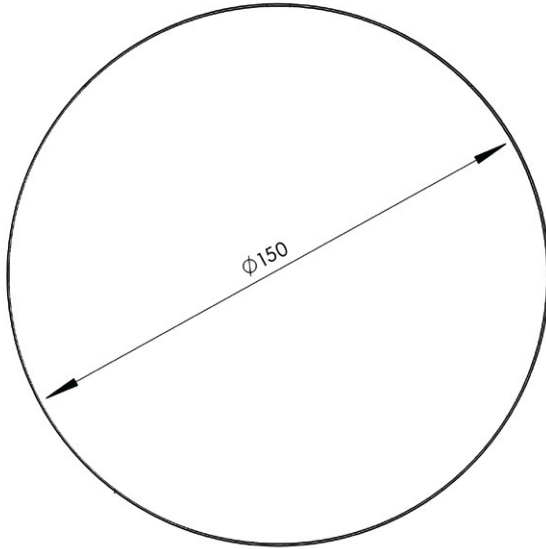

Find the drilling templates (scale 1:1) at the end of the manual as a fold-out

The In-Ceiling Set can be used in ceilings and walls that have a thickness of 6 to 22 mm/0.25 to 0.9 in

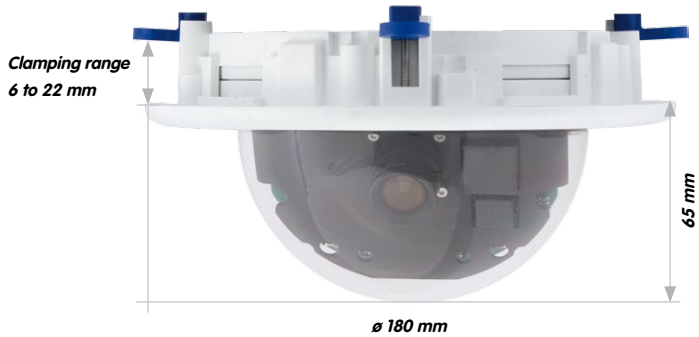
**Notes**

Find the folded drilling template at the end of the manual.

Make sure that the drilling template is not scaled or adjusted to the paper size when printing the PDF file (enlarged or reduced).

Required Parts

Please first check that all components supplied with the In-Ceiling Set are present in the original packaging. The following additional tools are required for installation:

- **Power drill** with matching hole saw (150 mm diameter) or **jigsaw**
- **MOBOTIX drilling templates** (at the end of this manual)
- **Scissors** to cut out the template
- **Pen** to mark the hole positions
- **Two blue In-Ceiling wrenches** from the In-Ceiling Set
- Materials and tools needed to connect the pre-installed MOBOTIX network cable in the camera with the on-site network cable



2.4.2 Procedure

1. **Prepare the network connection:** Run the network cable above the suspended ceiling and ensure that enough cable slack is available.
2. **Cut a hole for installation:** Cut a round hole for camera installation (e.g. with a 150 mm hole saw). Use the supplied cutting template of the In-Ceiling Set (fold-out at the end of the manual).

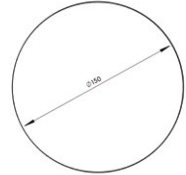

3. **Remove the camera outer shell:** Remove all four Allen screws using the supplied Allen wrench and lift off the outer shell (not mounted upon delivery).



4. **Remove the mounting ring:** Separate the mounting ring from the camera housing. This ring is not required to mount the camera in the In-Ceiling Set.

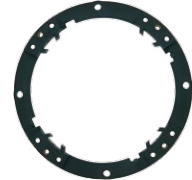

5. **Place the camera in the In-Ceiling Set:** The dovetail guides at the back of the camera housing fit exactly into the openings of the In-Ceiling mounting ring. To make the camera even more secure (e.g. for mobile use), push the four clamps (item 3.4) into the square notches above the dovetail guides until you hear them click into place.



6. **Connect the cable:** Connect the on-site network cable to the camera network cable using a standard connector.



7. **Insert the camera and the In-Ceiling Set into the hole:** Make sure that all winged cams are retracted before placing the In-Ceiling Set with the camera into the hole. Tightening the screws of the In-Ceiling Set extends the winged cams, thus firmly holding the set in place.

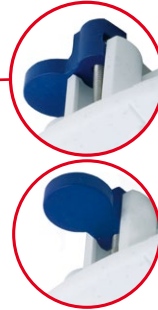

The blue winged cams (see left) automatically secure the In-Ceiling Set in the ceiling when tightening the screws

8. **Install the decorative ring:** Use the two wrenches from the In-Ceiling Set to place the ring on the set as shown in the figure and turn the ring clockwise until it stops.



Installing the decorative ring: turn clockwise

The two wrenches from the **In-Ceiling Set** are also used for **dismounting**. Insert them as shown and turn the ring counter-clockwise. Loosen the screws of the In-Ceiling Set; this will automatically retract the winged cams. You can now remove the In-Ceiling Set, with the camera still attached, from the ceiling.



Removing the decorative ring: turn counter-clockwise - only relevant when completely removing the camera

9. Proceed to *Section 3.3.1, «Aiming and Adjusting the Lens»*.

2.5 Installing the Vandalism Set



2.5.1 Mounting Instructions

The Vandalism Set provides additional security and protection for D25M cameras with little effort and at a low cost. It is ideally suited for use under particularly demanding conditions (such as prisons, trouble areas, train stations, etc.). The set consists of a robust stainless steel outer shell that is available in five different colors and a reinforced plastic dome.

To install the Vandalism Set, replace the standard plastic outer shell supplied with the D25M IT/Secure with the stainless steel outer shell of the Vandalism Set (including the safety screws and four mounted spacers). In addition, replace the original dome of the D25M IT/Secure with the reinforced dome of the Vandalism Set.

Available Variants of the MOBOTIX D25M Vandalism Outer Shell

First, make sure that all parts have been properly delivered.



The Following Additional Tools Are Required for Installation:

- **Allen wrench** for removing the standard outer shell (included in the D25M packaging)
- **Screwdriver with bit receptacle** for the two-hole driver bit



2.5.2 Procedure

- **Remove the camera outer shell:** Remove all four Allen screws using the supplied Allen wrench and lift off the outer shell.



- **Remove the standard dome:** Unscrew the dome from the housing (**counter-clockwise**). Package and store the standard dome for possible use at a later time.



- **Aim and adjust the lens:** When mounting the camera for the first time, please proceed to *Section 3.3.1, «Aiming and Adjusting the Lens»*.

- **Mount the reinforced dome of the Vandalism Set.** Tighten it **in a clockwise direction** using a soft cotton cloth. If necessary, clean the dome with a cotton cloth before installing it.



- Insert the four spacers included in the **Vandalism Set**.

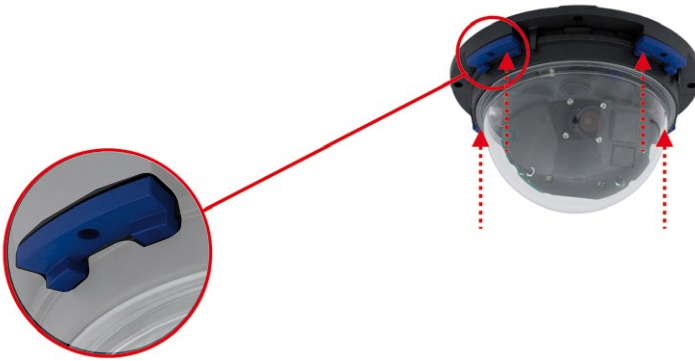

- Now attach the **stainless steel outer shell** of the Vandalism Set using the safety screws. Tighten the screws into place using the supplied two-hole driver bit.



2.6 Installing the Wall Mount



2.6.1 Mounting Instructions

The Wall Mount allows you to easily mount D25M cameras to walls or extensions, both indoors or outdoors. The camera remains IP65 weatherproof (dust-proof and resistant to water jets). The Wall Mount also covers RJ45 flush-mounted sockets and has ample space for additional modules (Mx2wire, WLAN, batteries, etc.).

Before mounting the MOBOTIX D25M with the Wall Mount, you must prepare the network connection and drill the holes for the fixtures:

- The **on-site network cabling** is passed through the opening in the back of the Wall Mount. The cable and the required (standard) connector for the camera cable (patch cable) are ideally protected by a robust wall sealing made from foam rubber. Nothing is visible or accessible from the outside. The Wall Mount may be mounted directly on top of surface- or flush-mounted sockets. Maximum width x height of the socket: 88 mm x 80 mm.
- Only use the **factory installed patch cable** of the D25M (50 cm cable length) or a MOBOTIX cable that is available as an accessory in various lengths.
- All openings of the camera housing need to be properly sealed. This is the only way to guarantee that the camera remains weatherproof.
- The supplied screw anchors should be used for the **drill holes** in the wall. Use the drilling template for the D25M Wall Mount (fold-out at the end of this manual) to mark the exact position for the drill holes and the holes through which the cables will later be fed.



Direct installation over surface- and flush-mounted sockets

Drilling Template Wall Mount

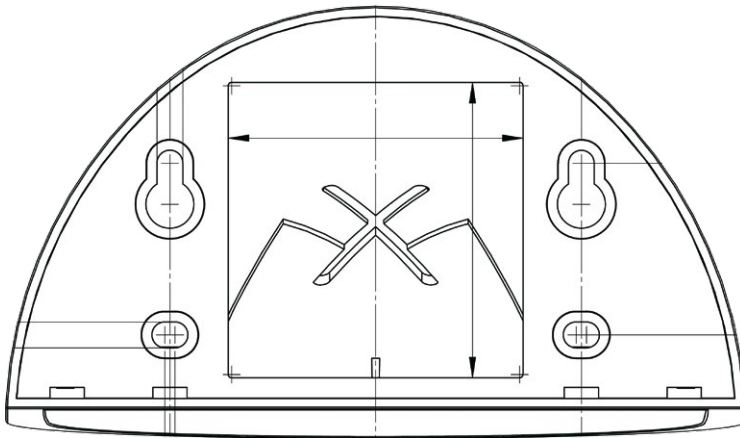

Find the drilling templates (scale 1:1) at the end of the manual as a fold-out

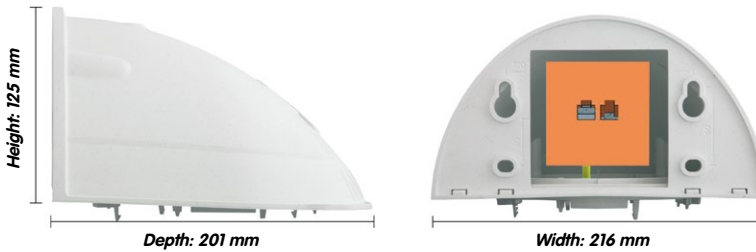

Direct installation over surface- and flush-mounted sockets

Notes

Find the folded drilling template at the end of the manual.

Make sure that the drilling template is not scaled or adjusted to the paper size when printing the PDF file (enlarged or reduced).

Scope of Delivery and Required Parts

Please first check that all the components supplied with the Wall Mount Set are present in the original packaging. The following additional items are required for installation:

- **Power drill** for screw anchor holes
- **Screwdriver**
- **MOBOTIX drilling templates** (at the end of this manual)
- **Scissors** to cut out the template
- **Pen** to mark hole positions
- **Materials and tools** needed to connect the pre-installed MOBOTIX network cable in the camera with the on-site network cable.
- Clean and soft **cotton cloth**



2.6.2 Procedure

1. **Remove the camera mounting ring:** Separate the black mounting ring from the camera housing. This ring is not required when mounting the camera to the Wall Mount. If the D25M was not in its original packaging, then it may be necessary to remove the outer shell with the four Allen screws beforehand.

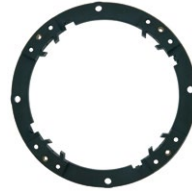

2. **Separate the bottom plate from the Wall Mount:** The bottom plate is used to hold the camera and is only attached and screwed into place during a later step.



3. **Pass the camera cable up through the bottom of the bottom plate:** Ensure the orientation is correct. The spring clips should be on the underside of the bottom plate.



4. **Snap the camera into place on the bottom plate:** Firmly push the camera into the Wall Mount. The plastic spring clips will snap into place when the trapezoidal elements on the rear of the camera housing exactly match up with the corresponding openings on the Wall Mount.



5. **Mount the Wall Mount (without camera):** Stick the black wall sealing to the back of the Wall Mount (remove the adhesive foil first, the surface must be clean and free of grease). Pass the network cable through the large square opening and into the Wall Mount. Use the included screws to install the Wall Mount (without the camera) at the intended position. Pass the network cable through the large square opening on back side of the Wall Mount.



6. **Connect the cable:** Prepare the on-site network cable for connection with the camera patch cable using a standard connector. Excess cable can be stored easily within the Wall Mount.



7. **Install the bottom plate with the camera in the Wall Mount:** Connect the camera patch cable to the network cable. Then mount the bottom plate with the camera in the slots from below and fix it in place on the Wall Mount using the 4 Allen screws (Allen wrench included).



8. Proceed to *Section 3.3.1, «Aiming and Adjusting the Lens».*

2.7 Installing the Corner and Pole Mount



2.7.1 Mounting Instructions

The 3 mm thick stainless steel Corner and Pole Mount is extremely robust and rust-proof. It is used (exclusively) in conjunction with the Wall Mount in situations where you want to mount a D25M IT/Secure to a pole or wall corner. The Wall Mount required for complete installation must be ordered separately.

The mounting pole should have a diameter of between 60 and 180 mm. Attaching the camera to the corner of a wall not only makes sense from an aesthetic perspective, but also allows you to monitor an area that is not specifically covered by the camera without incurring major building modification costs. In such cases, only the lens of the camera has to be repositioned.

By design, the Corner and Pole Mount does not allow the use of a flush-mounted socket.

Required Parts

Please first check that all the components supplied with the Corner and Pole Mount Set are present in the original packaging.

The Following Additional Tools Are Required For Installation As A Pole Mount:

- **Screwdriver**
- Materials and tools needed to connect the pre-installed MOBOTIX network cable in the camera with the on-site network cable

The Following Additional Tools Are Required For Installation Of The Corner Mount:

- **Power drill** for screw anchor holes
- **Screwdriver**
- **Scissors** to cut out the template
- **Pen** to mark hole positions
- Materials and tools needed to connect the pre-installed MOBOTIX network cable in the camera with the on-site network cable



2.7.2 Mounting to a Pole



Use the supplied stainless steel straps to affix the Corner and Pole Mount to a pole.

- Guide the supplied **stainless steel straps** through the openings in the Corner and Pole Mount as shown in the diagram. Make sure that you are using the slots of the mount that best fit for the thickness of the pole. The stainless steel straps allow attaching the mount to poles with diameters between 60 and 180 mm.



- Guide the on-site network cable from behind through one of the large round holes of the Corner and Pole Mount. In order to properly protect the cabling, it is best to pass the cabling from the inside of the pole through the Corner and Pole Mount directly into the camera (concealed cabling). **Note: The cable length from the pole should be at least 80 cm!**



- **Tighten the** stainless steel straps on the Pole Mount with a screwdriver. If necessary, the ends of the straps can be cut off.



2.7.3 Mounting to a Wall or Building Corner



Use the supplied screw anchors, screws and washers to affix the Corner and Pole Mount to a building corner.

- Mark the **four screw anchor holes** on the corner of the building, ensuring that the arrows on the mount point upwards. Drill the holes with a 10 mm wall drill.

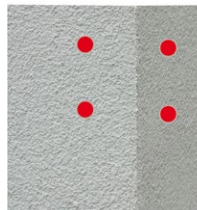

- Pass the on-site network cable through one of the large round holes at the back of the Corner and Pole Mount, then through one of the 16 mm diameter holes on the front of the mount. In order to properly protect the cabling, you should let the cabling run from the inside of the building through the Corner and Pole Mount directly into the camera (concealed cabling). **Note: The cable length from the building corner should be at least 80 cm!**



- Place the included **wall anchors** in the drilled holes and screw the Corner and Pole Mount into place on the corner of the building using the Torx screws and washers. Use the supplied drilling template (fold-out at the end of this manual) to mark the exact positions for the drill holes.



2.7.4 Mounting the Wall Mount to the Corner and Pole Mount

- Feed the network cables **through the appropriate hole at the back** of the Outdoor Wall Mount. The wall sealing on the Wall Mount must be in place already.
- Use the 6 x 20 mm Allen screws, Ø 6 mm washers and M6 nuts included with the Corner and Pole Mount and **attach the Wall Mount to the Corner and Pole Mount.**
- Continue with the remaining work steps as described in *Section 2.6, «Installing the Wall Mount»!*



2.8 Replacing the MicroSD Card

The camera must be taken down to remove, insert or replace a MicroSD card. To avoid data loss, be sure to deactivate MicroSD card recording in the camera software and reboot the MOBOTIX camera before removing the card.



Caution

A MicroSD card may only be removed from the camera after you have deactivated recording to a Flash device and rebooted the camera. Failing to do so may lead to data loss! Before inserting the MicroSD card, make sure that it is not write-protected!

2.8.1 Removing a MicroSD Card

- **Deactivate recording:** Recording to MicroSD card must be deactivated (**Admin Menu > Storage on External File Server / Flash Device**). If MicroSD card recording is still active, deactivate recording and reboot the camera. *Section 3.5, «MicroSD Card Recording», contains more information on this topic.*

- **Remove the outer shell:** Remove all four Allen screws using the supplied Allen wrench. Take off the outer shell.



- **Remove the camera dome.** Take the delivered plastic foil or a cotton cloth and remove the dome by turning it in counter-clockwise direction.



- **Remove the MicroSD card:** Gently push the MicroSD card into the card slot of the camera. The card is released from the slot and can be removed from the camera.



Push-push operation: only remove the MicroSD card after first gently pushing it in



Click!

2.8.2 Inserting a MicroSD Card

1. **Insert the MicroSD card:** Push the MicroSD card into the card slot as shown, until an audible and perceptible click indicates it is in place.



Push-push operation:
insert the MicroSD card
and push it in gently



- **Remove the camera dome.** Take the delivered plastic foil or a cotton cloth, insert the dome into its seat and turn it in clockwise direction.



- **Attach the outer shell:** Place the outer shell onto the camera and tighten all four Allen screws using the supplied Allen wrench. Make sure that the rubber seal is seated properly.



- **Activate recording:** If you have inserted a MicroSD card that has already been MxFFS formatted, you can activate recording under **Admin Menu > Storage on External File Server / Flash Device**. Once the camera has been rebooted, it automatically activates recording.
- **If you are using a new MicroSD card,** it must first be formatted as described in *Section 3.5, «MicroSD Card Recording»*.

2.9 Network and Power Connection

2.9.1 Notes on Cable Lengths and Power Supply

- Power may only be supplied to the camera via its Ethernet connector. A MOBOTIX Power Adapter or similar high-quality PoE product is recommended to provide the power supply via the network cable:
 - **one camera:** with the Network Power Adapter (MX-NPA-PoE)
 - **multiple cameras:** with quality PoE products conforming to IEEE 802.3af
- The **maximum length** of the network cable for power supply over an Ethernet cable is **100 m**.
- Make sure that you only use switches or routers that support the **10/100 Mbps Ethernet interface** of the camera. Check for LED activity on the corresponding port of the switch or router. When deploying several cameras, read the notes in *Section 4.11, «Operating Multiple Cameras»* in the *Software Manual*.
- It is highly recommend to use uninterruptible power supplies (UPS) to provide back up power.
- If you are using IEEE 802.3af Power over Ethernet network components to supply power to MOBOTIX cameras, make sure, if possible, that these components do not have a fan. Since the power consumption of MOBOTIX cameras is very low compared to other products, the reliability of the entire system is increased, thus extending the life of these components.

Caution

Appliances with a **maximum total power consumption of 3 W** may be connected to the MxBus connector **and** USB connector **if power is supplied to the camera using PoE class 3**. If **PoE Class 2** is used, **the power consumption of all the connected appliances should not exceed 1 W!**

For information on changing the PoE class, see *Section 2.9.8, «Variable PoE»*.

2.9.2 Connecting the D25M to the Network Using a Patch Cable

Using a patch cable and an MX-Overvoltage-Protection-Box or MX-NPA-Box offers the following advantages:

- Quick installation/deinstallation
- No shortening of cable even when installing/deinstalling several times
- Hose-proof/dust-proof connection in accordance with IP65
- Additional protection against overvoltages of up to 4 kV when using the MX-Overvoltage-Protection-Box.

Connection of additional devices with more than 1 W (via MxBus/USB):
Max. ambient temperature +50°C / +122°F

Connecting the Patch Cable to an MX-Overvoltage-Protection-Box, an MX-NPA-Box or a Standard Network Outlet

To establish the network connection of the camera using an MX-Overvoltage-Protection-Box or an MX-NPA-Box, remove the blue bayonet catch and the blue sealing plug from the right-hand side of the box. Insert the MOBOTIX patch cable into the box and fasten the cable using the blue bayonet catch.

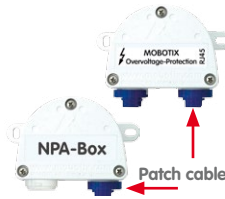

For additional, information on how to install an **MX-Overvoltage-Protection-Box** or an **MX-NPA-Box**, open the **Products > Accessories > Interface Boxes** section on www.mobotix.com.

When using a standard network outlet (only for indoor installations), insert the MOBOTIX patch cable of the D25M directly into the network outlet.

2.9.3 Power Supply Using a Switch

1. Connect the factory pre-installed cable of the camera to the **camera** connector of the PoE adapter.
2. Connect the **LAN/Power** connector of the PoE adapter to the Ethernet connector of the switch/router or the Ethernet port.
3. Plug the RJ45 connector of the power supply unit into the **PC/Power** connector of the PoE adapter.

IP addresses in the diagram are shown only as an example

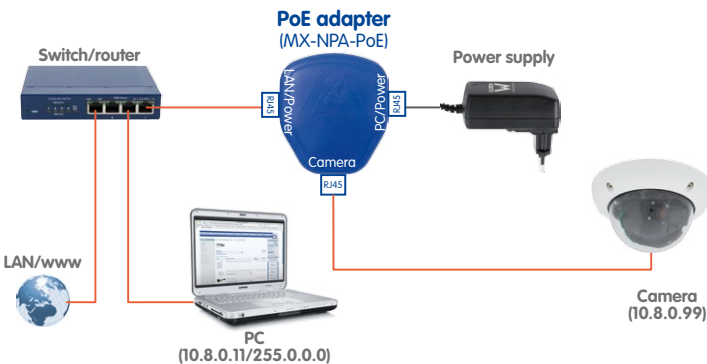

IP addresses in the diagram are shown only as an example

2.9.4 Power Supply When Connected Directly to a Computer

1. Connect the factory pre-installed cable of the camera to the **camera** connector of the PoE adapter.
2. Connect the **PC/Power** connector of the PoE adapter to the Ethernet port of the computer.
3. Plug the RJ45 connector of the power supply unit into the **LAN/Power** connector of the PoE adapter.

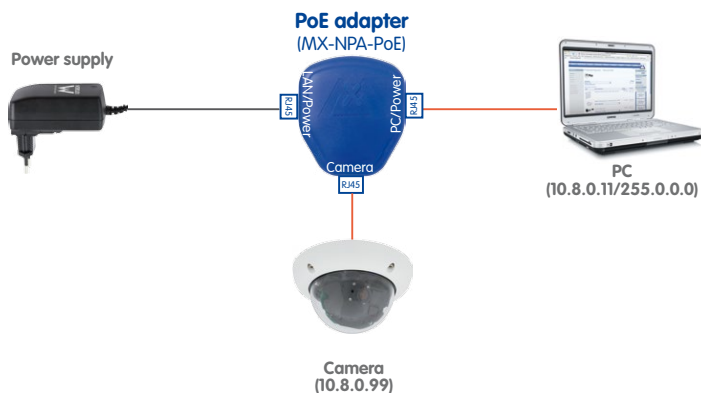

2.9.5 Power Supply with Power-Over-Ethernet Products

Connect the factory pre-installed cable of the camera to the Ethernet connector of the PoE switch/router. The switch/router must support the PoE standards IEEE 802.3af or IEEE 802.3at.

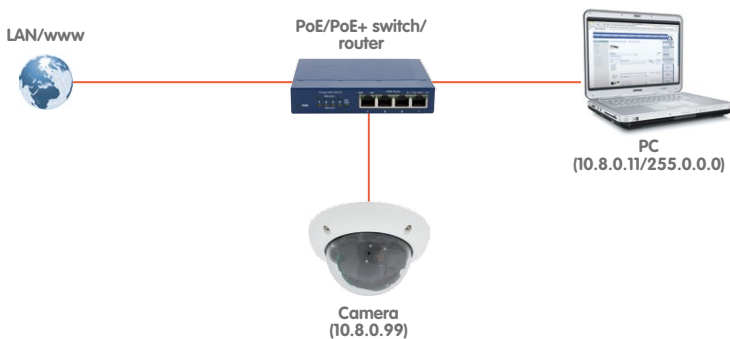

IP addresses in the diagram are shown only as an example

2.9.6 Connecting a USB Cable

Using the USB connector (red arrow in figure), you can attach existing expansion modules, such as the MOBOTIX ExtIO (USB), the MX-232-IO-Box or external USB hard drives to the camera in a weatherproof and well-protected manner.



You should use a USB cable with an **angled** MiniUSB plug inside the housing of the D25M

Procedure

- **Uninstall camera:** Remove the camera so you can access the connectors on the back.
- **Remove the outer shell:** Remove all four Allen screws using the supplied Allen wrench. Take off the outer shell.
- **Remove the camera dome:** Take the delivered plastic foil or a cotton cloth and remove the dome by turning it in counter-clockwise direction.
- **Tilt the main board:** If required, release the two stainless steel Allen screws and tilt the mainboard so you can access the USB connector.
- **Remove the sealing plug:** Push one of the three sealing plugs out of the housing by pushing it from the inside.
- **Guide USB cable through wire plug:** Gently push the angled connector of the MOBOTIX USB cable (see *Section 1.4, «Available Accessories»*) through the supplied black single-wire plug (item 1.16).
- **Insert cable plug with USB cable:** Push the wire plug with the cable from the rear into the housing (make sure that the plug is seated properly).
- **Connect USB cable:** Push the MOBOTIX cable with the angled MiniUSB plug into the USB connector (red arrow in figure).



- **Remove the camera dome:** Take the delivered plastic foil or a cotton cloth, insert the dome into its seat and turn it in clockwise direction.
- **Attach the outer shell:** Place the outer shell onto the camera and tighten all four Allen screws using the supplied Allen wrench. Make sure that the rubber seal is seated properly.



2.9.7 Connecting a Two-Wire MxBus Cable

In order to attach MxBus modules, you need to use the supplied MxBus connector with two-wire connection line and two single-wire connectors:



The length of the entire MxBus wiring must not exceed 50 m/55 yd!

You can use such a cable to connect additional MOBOTIX modules (e.g., the MX-GPS-Box or the MX-232-IO-Box) to the D25M.



Note that you can attach one MxBus cable (with two wires) to the MxBus connector (red arrow in figure). Take care not to switch the polarity of the wires. It is recommended to use the same wire color for +/– for the entire MxBus system (e.g., red = +, blue = –).

Procedure

- **Uninstall camera:** Remove the camera so you can access the connectors on the back.
- **Remove the outer shell:** Remove all four Allen screws using the supplied Allen wrench. Take off the outer shell.
- **Remove the camera dome.** Take the delivered plastic foil or a cotton cloth and remove the dome by turning it in counter-clockwise direction.



- **Remove the sealing plug:** Push one of the three sealing plugs out of the housing by pushing it from the inside.



- **Prepare MxBus cable:** Strip 5 mm (1/5 in) of insulation from the wire ends of the MxBus cable. Then push each wire into one of the holes in the single wire plug (this prevents humidity from entering the camera).

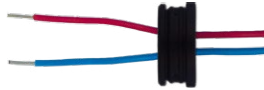

- **Insert single-wire plug with MxBus cable:** Push the single-wire plug with the MxBus wires from the rear into the housing (make sure that the plug is seated properly).



- **Insert MxBus connector:** Push the MxBus connector into the receptacle on the mainboard (red arrow in figure).



- **Connect MxBus cable:** Use one single-wire connector to join one wire color of the MxBus cable and repeat for the other color. Store the connectors within the camera housing so that they do not obstruct the main board when adjusting the camera image.



- **Remove the camera dome:** Take the delivered plastic foil or a cotton cloth, insert the dome into its seat and turn it in clockwise direction.



- **Attach the outer shell:** Place the outer shell onto the camera and tighten all four Allen screws using the supplied Allen wrench. Make sure that the rubber seal is seated properly.



2.9.8 Variable PoE

The power consumption of the camera depends on the functions in use as well as any peripheral devices connected (see table). PoE classes 1, 2 or 3 may be selected in the browser-based user interface in order to optimally adjust the camera to your system design (PoE switch in use, emergency power concept, etc.).

PoE Power Level Classes (IEEE 802.3af Standard)		
Class	Max. power consumption	Camera operating mode and peripheral devices
1	0.44 W–3.84 W	LowPower mode; no peripheral devices (available soon)
2	3.84 W–6.49 W	Normal mode; max. 1 W for MxBus peripheral devices
3	6.49 W–12.95 W	FullPower mode; max. 2.5 W for MxBus peripheral devices (for example, MX-GPS-Box and MX-232-IO-Box to MxBus), max. 4 W for peripheral devices to MxBus and USB interface

Caution

If the total power consumption of the camera and peripheral devices exceeds the power provided by the PoE switch for the specified class, the switch can disconnect the camera from the power supply. ***In this case, the camera will only be accessible again once the peripheral devices have been disconnected from the camera and the camera has been restarted.***

Variable PoE:
Multiple cameras
can be operated
simultaneously from
the same switch

The default setting is usually fine, and nothing needs to be changed. However, the PoE power class must be changed in the browser if a higher or a lower power class is required for your application:

1. **Select Admin Menu > Network Setup > Ethernet Interface** (for experts).
2. Click on **Change** under **Power Supply**.
3. A **Power Wizard** will appear to guide you through the PoE configuration steps.
4. Next, restart the camera: Disconnect the camera from the power supply. Then reconnect it, for example, by disconnecting and then reconnecting the Ethernet cable at the PoE switch.

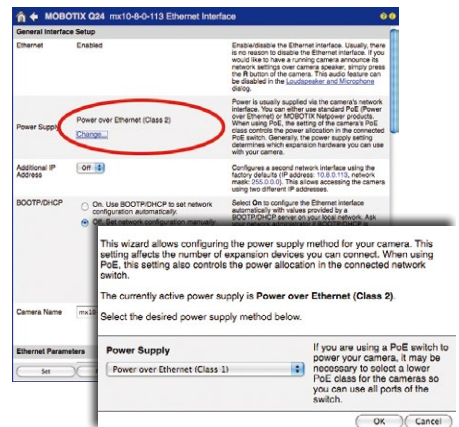

2.9.9 Camera Startup Sequence

As soon as the camera's power supply has been established, the two LEDs will show the progress of the startup sequence (see Section 5.4.3, «LED Signals and LED Configuration» in the MOBOTIX Camera Software Manual).

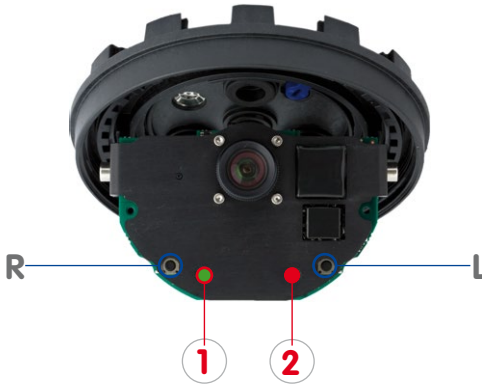

LED default settings:

- 1 Power (on), Error (flashing)
- 2 Recording (flashing)

- **Booting:** Immediately after connecting the power supply, the red LED lights up, flashes for two seconds, then stays on permanently red. A camera self-test is carried out at this point, and the entire system is started. In case of an error, the camera will start using the backup system.
- **Waiting for key pressed:** Both LEDs light up for four seconds. If you press the **R** or **L** key of the camera during this time, the camera will execute the corresponding function (see Section 3.2.6, «Starting the Camera with an Automatic IP Address (DHCP)» and Section 3.2.5, «Starting the Camera with the Factory IP Address»). Use a suitable device to press a key (a ball-point pen, for example).
- **Ready:** Once the camera software has been started, the green LED is on permanently and the red LED blinks. You can now reach the camera via the network using a browser.



Notes

During the startup sequence of the camera, the LEDs will always light up, even if they have been deactivated in **Admin Menu > LED Setup**.

3 OPERATING THE CAMERA

3.1 Manual and Automatic Operation - Overview

MOBOTIX cameras do not require any extra software. Thus, you can set up and operate the MOBOTIX camera using a JavaScript-enabled browser on all common operating systems (such as Window, Linux, Macintosh, etc.). As an alternative, you can also use the MOBOTIX applications MxControlCenter and MxEasy. Follow these steps to set up the camera:

1. **Connect the camera to the network.** Power is supplied directly via the network cable (see *Section 2.1.3*)
2. **Set up the camera's network parameters:**
 - **Manually using a web browser** (see *Section 3.2.1*, then *Section 3.2.2*)
 - **Automatically using MxControlCenter/MxEasy** (see *Section 3.2.3* and *3.2.4*) or **via DHCP** (see *Section 3.2.6*)
3. **Configure the camera** using the browser-based user interface.

Every MOBOTIX camera comes preconfigured with a fixed IP address in the 10.x.x range (e.g. 10.8.0.99). However, local computer networks usually have IP addresses in the 172 or 192 ranges. In order to access a MOBOTIX camera via the network, the camera needs to obtain an IP address in the same address range. You can **set up the network parameters of the MOBOTIX camera using one of the following methods: Manually, using MxCC and MxEasy or by DHCP.**

Download the MxEasy and MxControlCenter software for free at www.mobotix.com

Camera software in the browser



3.1.1 Manually Using a Computer in the 10.x.x.x IP Address Range

You can set up the camera's network parameters using a browser and the embedded camera software. To do this, connect the camera to a computer or a network that is using a 10.x.x.x IP address range (see Section 3.1.1, «Manually Using a Computer in the 10.x.x.x IP Address Range»). Once this has been completed, you can enter the camera's default IP address in the browser address bar of the computer (see Section 3.2.2, *The First Images And The Most Important Settings In The Browser*). Next, click the **Admin Menu** button to open the camera's Quick Installation in the browser's user interface. This is where you can configure the desired network parameters of the camera. Once you have completed the Quick Installation, you can connect the camera with its new network parameters to the desired network.

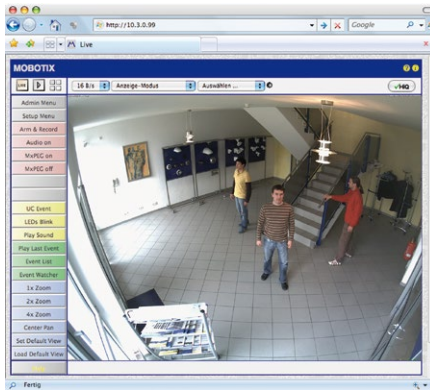

The default IP address of your camera is printed on a sticker on the back of the camera

Advantages

- The camera does not need to be physically accessible, i.e. it can remain mounted to a pole, for example.
- No additional software is required.
- The network parameters can be set flexibly through manual entry.

Disadvantages

- The computer or the network need to operate in the 10.x.x.x IP address range or need to be able to access such a network.
- The setup does not work automatically.
- You need to know the relevant network parameters.

3.1.2 Automatically Using MxControlCenter or MxEasy

You can set up the camera's network parameters using the free of charge video management software MxControlCenter or MxEasy (see *Section 3.2.3* and *Section 3.2.4*). You can also use one of these applications to automatically configure the network parameters of MOBOTIX cameras that are not operating on the same IP address range as the computer.

MxControlCenter
software (free download
from www.mobotix.com)

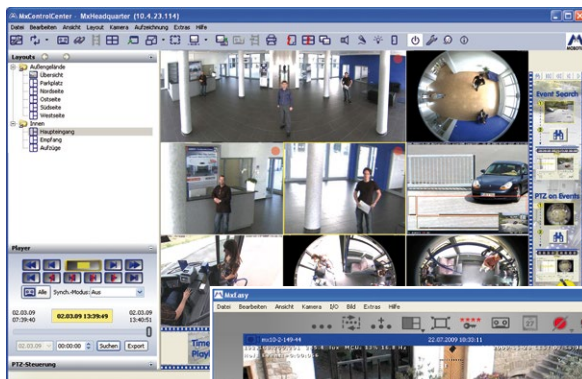

MxEasy (free download
from www.mobotix.com)

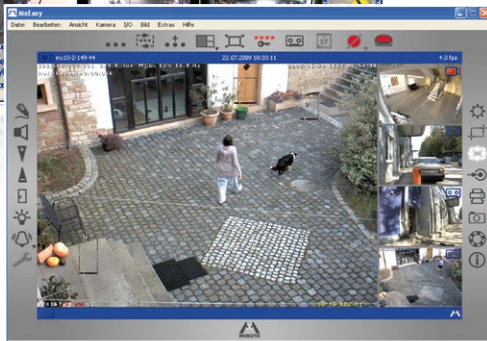

Advantages

- You can connect the camera directly to the target network.
- The camera does not need to be physically accessible, i.e. it can remain mounted to a pole, for example.
- The camera can be configured to automatically receive an IP address (optional).
- The network parameters can be manually set (optional).
- You do not need to access the camera user interface.

Requirement

- The MxControlCenter or MxEasy video management software needs to be installed on the computer.

3.1.3 Automatically Using DHCP

The camera can automatically obtain its network parameters using DHCP. This requires the network to have a functioning DHCP server (e.g. a DSL router with activated DHCP server) and the camera must be booted using DHCP (see *Section 3.2.6, «Starting the Camera with an Automatic IP Address (DHCP)»*). The IP address automatically assigned by the DHCP server can be announced via the speaker of an activated ExtIO that is connected to the D25M as soon as the camera has booted successfully.

The ExtIO module is available from the MOBOTIX accessories program

Advantages

- You can connect the camera directly to the target network.
- Network parameters are automatically assigned.
- No additional software is required.
- You do not need to access the camera user interface.

Disadvantages

- The camera needs to be physically accessible as you need to press a key on the camera housing to boot it using DHCP.
- Requires a running DHCP server on the network.
- The IP address must be determined by the administrator.



3.2 First Images and the Most Important Settings

Once the camera has been connected to the network, you need to set up the camera's network interface accordingly. This step involves setting up and checking the network parameters of the camera. If your network is already using an IP address in the 10.x.x.x range with a 255.0.0.0 network mask, you do not need to change the camera's network parameters. You can access the camera directly (see [Section 3.2.2](#)). If your network or computer does not use an IP address in the 10.x.x.x range (e.g. in the 192 or 172 ranges), you should follow one of the following methods for changing the camera's network parameters:

- **Manual Setup** ([Section 3.2.1](#))
- **Automatic Setup using MxControlCenter or MxEasy** ([Section 3.2.3](#) and [Section 3.2.4](#))

Notes

For the following examples, we will use a camera with the factory address 10.8.0.99. Replace this IP address with the IP address of your camera. You will find the IP address of your camera on a small sticker on the camera. Make sure that the IP addresses used in the following examples are not already being used by other devices in the network.

Hint: Pressing the **R** key on the camera prompts the camera to announce its current IP address over a speaker.

3.2.1 Manually Setting Up the Network Parameters in a Browser

In order to manually set up the network parameters of the MOBOTIX camera, you need a computer that is using a 10.x.x.x IP address. The computer's network parameters usually have to be changed for this purpose.

1. Change the Network Parameters of Your Computer:

Windows (2000, XP and Vista):

1. Open **Start > Settings > Control Panel > Network Connections**. Clicking **Properties** opens the dialog shown.
2. Double-click **Internet Protocol (TCP/IP)**. On the **General** tab, activate the **Use the following IP address** option. Enter an IP address in the 10.x.x.x range in this field (e.g. 10.8.0.11).
3. Once all dialogs have been closed, the computer will have the IP address 10.8.0.11.

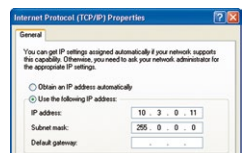

Caution:
Netmask 255.0.0.0

Linux/Unix:

1. Open a terminal as `root` user.
2. Enter the following command: `ifconfig eth0:1 10.8.0.11`
3. The computer is now also using the IP address 10.8.0.11

Mac OS X:

1. Open **System Properties > Network**.
2. Select **Ethernet**. In the **Configuration** field, select **Manual** and enter a 10.x.x.x IP address (e.g. 10.8.0.11).
3. Click **Apply** on the bottom right-hand side of the dialog to assign the computer the IP address 10.8.0.11.

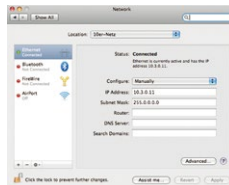

2. Set Up the Target Network Parameters of the Camera:

1. Open a web browser on the computer and enter the default IP address of the MOBOTIX camera in the address bar of the browser (e.g. 10.8.0.99). Pressing Enter displays the user interface of the MOBOTIX camera (see also Section 3.2.2, «First Images and the Most Important Settings in the Browser»).
2. Click the **Admin Menu** softbutton in the user interface of the MOBOTIX camera. The Quick Installation starts automatically once the `admins` user has logged on.

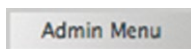

Note: The Quick Installation can also be executed at a later stage by opening **Admin Menu > Network Setup > Quick Installation** (see also Section 5.2, «Quick Installation» in the *Camera Software Manual Part 2*).

3. Enter the target network parameters of the camera on the appropriate page of the Quick Installation assistant.

Note: The network parameters can also be accessed at a later stage by opening **Admin Menu > Network Setup > Quick Installation**.

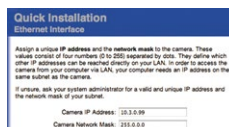

4. Once you have completed the Quick Installation and rebooted the camera, the new network parameters will be activated. The camera can now be connected to the target network and, if required, further configured.

Default access credentials
 User Name: `admin`
 Password: `meinsm`

3.2.2 First Images and the Most Important Settings in the Browser

Once the MOBOTIX camera has been connected to the power supply and to the network, you can access the user interface with the live camera image in the web browser. Internet Explorer, Firefox, Safari, Konqueror, Opera, Camino or any other graphical browser with activated JavaScript is suitable. It does not matter which operating system is used.

After entering the camera's IP address in the browser address bar, you will see the live screen of the MOBOTIX camera with its user interface controls, such as softbuttons, buttons for the different camera screens, pull-down menus (Quick Controls), symbols for accessing the online help and the camera status as well as status information elements above and below the live image.

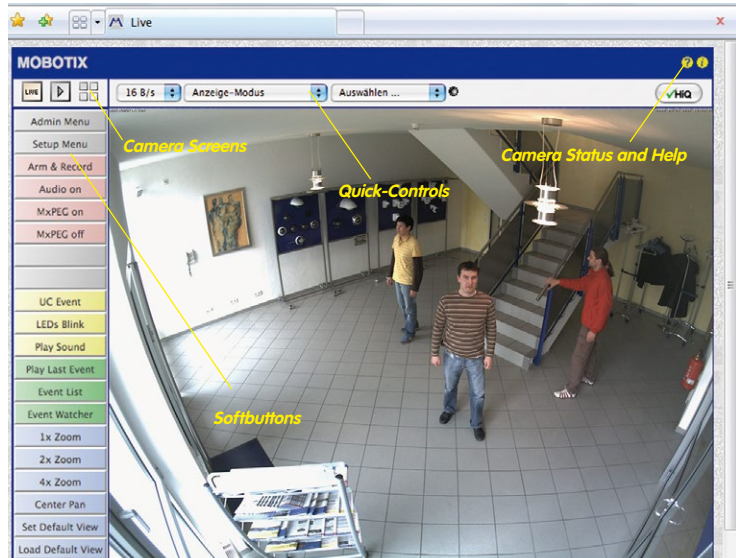

Notes

Default access credentials for the Administration Menu

User Name: **admin**

Password: **meinsm**

Camera Screens: Live, Player, MultiView

The MOBOTIX camera automatically displays the **live** screen when it starts up (factory default setting). You can set a different start page in **Admin Menu > Language and Start Page** (e.g. the **Guest** screen) to allow a restricted access to the live image.

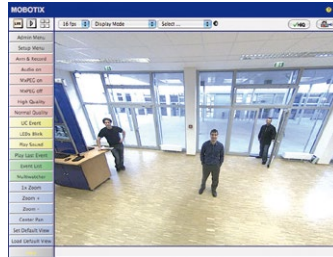

The other available standard screens include **Player** (playback of recorded images and video sequences) and the **MultiView** screen (displays several cameras with live or recorded images).

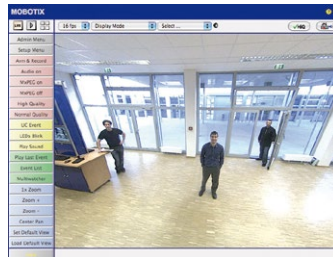

MultiView allows you to view several cameras via a "proxy" camera (especially useful if you want to access your cameras from outside of the network with reduced bandwidth) and the **PDA** mode provides a special screen for mobile devices.

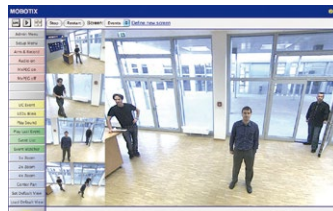

Live screen:
<http://<camera IP>/control/userimage.html>



Player screen:
<http://<camera IP>/control/player>



MultiView screen:
<http://<camera IP>/control/multiview>

PDA screen:
<http://<camera IP>/pda>

PDA Event List:
<http://<camera IP>/control/player?eventlist&pda>

Guest screen:
<http://<camera IP>/cgi-bin/guestimage.html>

Note

For more information on camera screens, see *Section 4.1.1, «Camera Screens in the Browser»*, the *Camera Software Manual Part 2* or the online help of the camera's browser interface.

Download
MxControlCenter
for free from
www.mobotix.com

3.2.3 First Images and Network Parameter Configuration in MxControlCenter

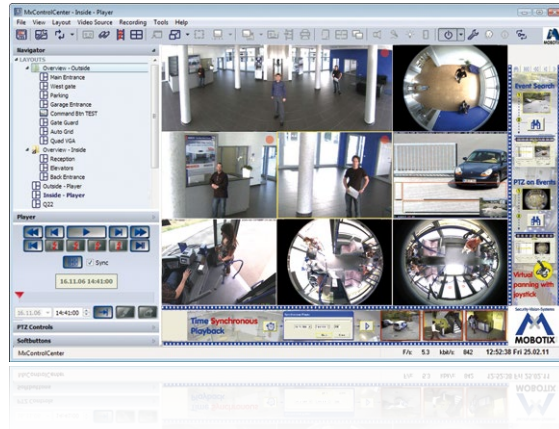

Installation

Download the setup file from the MOBOTIX website to install the latest version. The latest versions are available at www.mobotix.com in the **Support > Software Downloads > MxControlCenter** section.

To install MxControlCenter, simply double-click on the setup file and follow the instructions.

The selected files are copied to the computer (older versions will be removed automatically) and the designated shortcuts are created during the installation process (Desktop, Start Menu, etc.).

Caution

MxControlCenter will automatically attempt to find all MOBOTIX cameras in the physically-connected network (that is, even a MOBOTIX camera with a factory IP address of 10 . x . x . x). Make sure that the **firewall settings** on your computer are low enough so that MxControlCenter is not blocked. If any MOBOTIX cameras are found, MxControlCenter can **automatically reconfigure** them so that they are available in the current subnet of the computer. If you do not have permission to modify these settings on your computer, contact your system administrator for assistance.

MOBOTIX– Searching and Displaying MOBOTIX Cameras

Launch MxControlCenter after successful installation by double-clicking on the shortcut that was created during installation or the executable file **MxCC . exe** in the installation directory on your computer.

The **Add Video Sources** dialog box appears and the application automatically searches for MOBOTIX cameras in the local network when you launch the program for the first time. Select **Video Source > Add** from the menu to perform a camera search at a later time.

If your MOBOTIX camera is properly connected, it should appear together with the existing video sources in the following list:

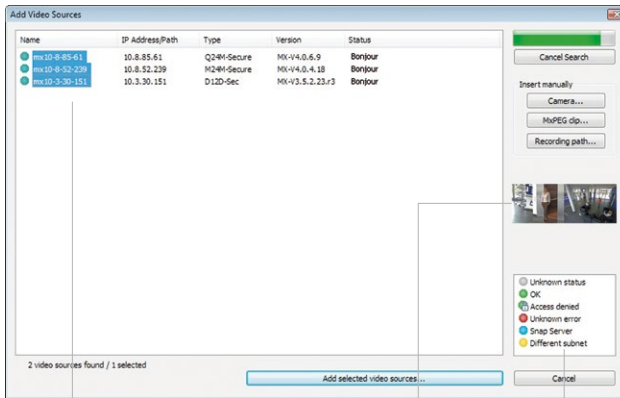

List of video sources

Camera preview



Legend

Automated Search For MOBOTIX Cameras

Note

Video sources in this context not only refer to MOBOTIX cameras, but also to third-party IP cameras, file server paths, MxPEG clips and analog cameras connected via MxServer (for example, analog dome cameras). These sources are not found automatically and need to be added manually.

Cameras Are Found But Are Located in a Different Subnet

The symbols in the first column and the legend in the dialog box indicate whether you can access a particular camera directly from the MxControlCenter, which is the case for all cameras designated with  (**OK**). Cameras designated with  (**different subnet**) are located in a different subnet. This usually applies to new cameras or cameras that have been reset to their factory settings.

Note

MxControlCenter finds all MOBOTIX cameras, even when the computer and the cameras are not located in the same subnet.

Once you have marked all of the desired video sources in the list with **OK**, you can now select the ones that you wish to display and manage in MxControlCenter. The live image is automatically displayed in the preview window when a camera is selected to help you identify the cameras.

For cameras marked with **Different subnet** or if you want to add additional video sources, follow the instructions in the following sections. You can also display the selected cameras directly in a layout. For more information, see «*Creating a New Layout*» further down.

Reconfiguring Cameras in a Different Subnet

If one or more MOBOTIX cameras are displayed with the status **Different subnet** (for example, cameras with a factory IP address), MxControlCenter automatically offers to configure the network settings of these cameras. In this case, the application displays the dialog box shown here after you have clicked on the **Add selected video sources** button. Click on **Yes** to configure the cameras to the subnet of the computer.

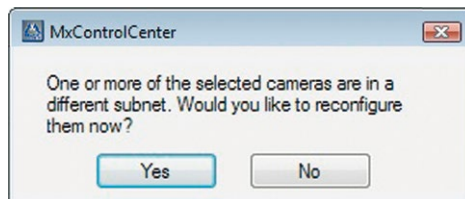

A DHCP server automatically assigns IP addresses for network devices in most networks so that you can automatically select the default setting **Get IP address automatically (DHCP)** in the **Configure Selected Cameras** dialog box.

Activate the **Use this IP address/this range** option if the IP address of a particular camera must be assigned manually (for networks with static IP addresses). Obtain the assigned IP address, subnet mask and standard gateway from your network administrator and enter the data. All you have to do is enter the range of IP addresses that includes the addresses of all of these cameras to reconfigure multiple cameras at the same time.

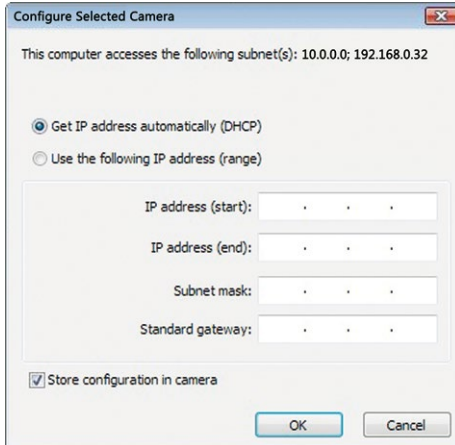

Make sure that the **Store configuration in the camera** checkbox is selected. This setting ensures that the cameras are displayed with the correct network settings even after they have been rebooted. Click on **OK** to close the dialog box.

Wait until MxControlCenter has changed the network settings and rebooted the cameras. The status of the reconfigured camera changes from **Different subnet** to **OK**.

Defining Additional Video Sources

In addition to the MOBOTIX cameras that are found automatically, you can also manually add video sources to the list of video sources for MxControlCenter.

- **Camera:** Here, you can enter the known IP address or DNS name of a MOBOTIX camera or a third-party IP camera if it was not found by the automatic search feature.
- **MxPEG clip:** Adds an MxPEG video clip previously recorded by a MOBOTIX camera as a video source.
- **Recording path:** Adds the path of an external file server where a MOBOTIX camera has recorded audio/video data. The videos or images recorded at that location can now be played back using the **Player** or **Video Search**.

Editing the Video Source List

Right-click on this list to open a shortcut menu from which you can select all video sources or cancel the selection. You can also use this method to remove from the list some or all of the video sources that you would not like to display or manage in MxControlCenter.

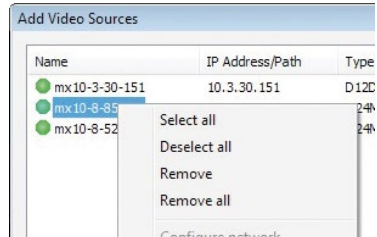

If you have cancelled the camera configuration process or need a password that differs from the camera's factory default password, you can also configure the camera from the shortcut menu at a later date and enter the user name and password required for reconfiguration at that time.

It is also possible to open the **Configure selected cameras** dialog box using the shortcut menu in order to change the camera network parameters.

Creating a New Layout

Select the camera or other video sources that you would like to display in a layout (a view with a group of selected cameras) in the **Add video sources** dialog box and then click on **Add selected video sources**.

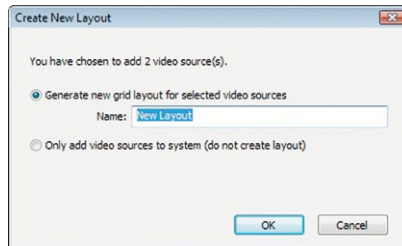

The **Create new layout** dialog box is displayed. If you select the **Generate new grid for selected video sources** option here, MxControlCenter automatically generates a grid layout that displays windows of the same size for all selected video sources. Give each layout a unique name (for example, underground garage).

If you select the second option, the video sources you selected are simply integrated in the MxCC system where you can use them to generate a layout at a later time.

Click on **OK** to confirm.

3.2.4 First Images and Network Parameter Configuration in MxEasy

Installing and Starting MxEasy

Download the current version of MxEasy from the MOBOTIX website (www.mobotix.com > **Support** > **Software Downloads** in the **MxEasy** area). Double-click the shortcut for the program or the program file.

Finding Cameras

When you start MxEasy for the first time on a computer, the MxEasy Assistant automatically begins to search for MOBOTIX cameras and displays all cameras found in a list. The camera list will be updated automatically as soon as new MOBOTIX cameras are connected to, or removed from the network.

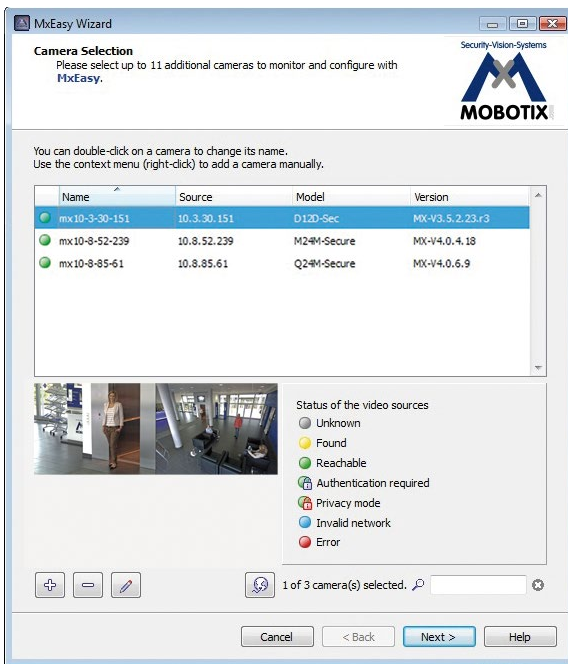

MxEasy also automatically monitors and displays the operating status of all cameras. Cameras that are not on the same subnet as the computer will get a differently colored symbol than the cameras that are on the same subnet. Likewise, the cameras that have an unknown password or for which no user name/password combination has been specified in MxEasy will be displayed in a different color. The following section *«Reconfiguring Network Addresses of Cameras»* contains information about cameras with the status **Invalid network** (for example, all new MOBOTIX cameras with factory settings).



Download MxEasy
for free from
www.mobotix.com

*Bonjour: automatic recognition of network services in IP networks

Reconfiguring Network Addresses of Cameras

Using Bonjour*, MxEasy finds not only cameras on the same network as your computer, but also MOBOTIX cameras located in other subnets (the **Invalid Network** status). In such a case, you would not be able to establish any connection to cameras in a different network or subnet (without going into much further detail regarding TCP/IP network configurations). This is possible, for example, when a camera with a factory IP address is connected to a network in which a DHCP server automatically assigns the IP addresses. MxEasy can automatically configure such a camera so that it is "integrated" into your existing network. To do so, you only have to select the affected camera in the list and then click on **Continue**.

After a security prompt, a new dialog box for configuring the selected camera is displayed.

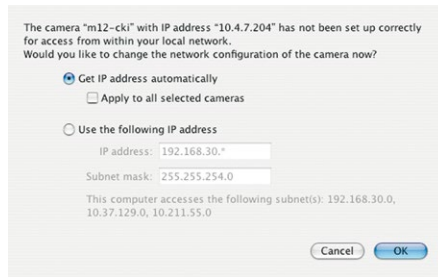

If your computer automatically obtains its IP address from a DHCP server, then this is certainly the best choice for that specific camera and most likely for all other cameras that have been found in a different subnet (**Get IP address automatically** option).

If you have assigned a static IP address to your computer, you will probably want to assign static IP addresses (issued by your system administrator) to every camera (the **Use this IP address** option). Normally, you enter the same configuration used for the network settings of your computer.

When you click on **OK**, the selected cameras are automatically reconfigured and they are located in the same subnet as the computer.

Integrating And Displaying Cameras

After a camera has been reconfigured, it has the status **Accessible** and can be integrated into MxEasy. The MxEasy Assistant then displays the **Define Integration Mode in MxEasy** dialog box.

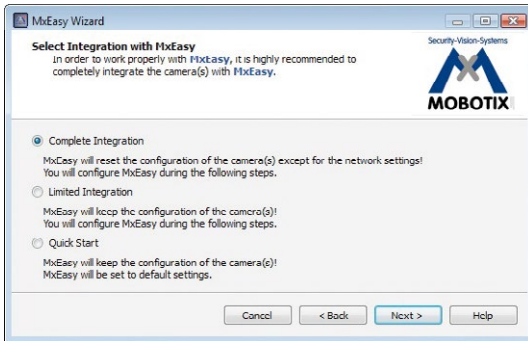

Here, you can jump directly to the main window of MxEasy with the current live camera image by activating the option **Quick Start**. However, some required detailed configurations may have to be made at a later time (for example, password protection, available bandwidth). For this reason, we recommend activating the option **Complete integration** and complete the remaining dialog boxes of the MxEasy Assistant until the main window appears.

After you are done with the MxEasy Assistant, the application's main window appears and displays the first camera:

For more information, see the **MxEasy User Manual**, which can be downloaded as a PDF file from the MOBOTIX website: www.mobotix.com > **Support** > **Manuels**.

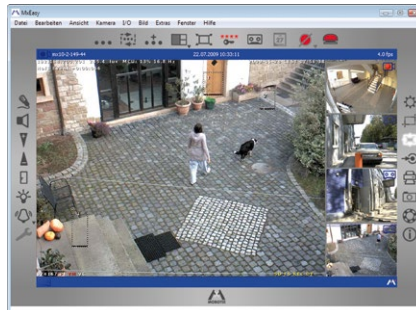

Main window with image of a D25M

Passwords and camera settings will not be changed

3.2.5 Starting the Camera with the Factory IP Address

If your network has a DHCP server, you can start the MOBOTIX camera with DHCP support. The camera automatically obtains an IP address from the DHCP server and announces the new network data. Please note that this announcement can only be heard if the camera is connected to an external speaker.

1. If the camera is powered on, disconnect the power supply by unplugging the corresponding cables and then reconnect the power supply.
2. Wait until both LEDs light up simultaneously for the first time.
3. **Press the L key within the next four seconds and hold it down** (if you need to try again, go back to Step 1). Use a suitable device to press a key (a ball-point pen, for example).

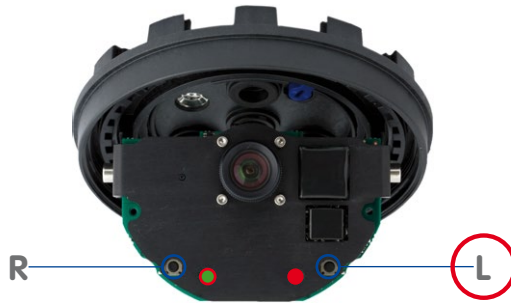

4. **After about 30 to 45 seconds**, the camera emits a single sound (“boing”).

The camera has finished booting and can now be used (e.g., MxEasy, MxControlCenter, MOBOTIX App, web browser).

Notes

If you use the camera's **L key** to load the factory network configuration, this configuration is not automatically saved in the camera's flash memory. When the camera is next rebooted without using the **L key**, the last stored network configuration will be used. To permanently store the new network configuration in the camera's flash memory, open **Admin Menu > Store**.

As opposed to resetting the camera using **Admin Menu > Reset configuration to factory defaults**, the user information will **not** be reset if the camera is booted using the factory IP address.

Make sure you store the default network configuration to the permanent flash memory

3.2.6 Starting the Camera with an Automatic IP Address (DHCP)

Under certain circumstances, you may have to reset the camera to its factory IP address. This could be the case, for example, if the IP address has been lost or the camera does not respond to the last known IP address. Proceed as follows to start up the camera with its factory IP address:

1. If the camera is powered on, disconnect the power supply by unplugging the corresponding cables and then reconnect the power supply.
2. Wait until both LEDs light up simultaneously for the first time.
3. **Press the R key within the next four seconds and hold it down** (if you need to try again, go back to Step 1). Use a suitable device to press a key (a ball-point pen, for example).



4. **After about 30 to 45 seconds**, the camera emits a double sound (“boing boing”).

The camera has finished booting and can now be used (e.g., MxEasy, MxControlCenter, MOBOTIX App, web browser).

Notes

Starting the camera with an automatic IP address (DHCP) is only **temporary**. The network configuration of the camera can be permanently set to DHCP under **Admin Menu > Ethernet Interface**.

Make sure that the network has a functioning DHCP server when starting the camera with DHCP support. If this is not the case, the camera cannot obtain a valid IP address and will use its last IP address.

You should also make sure that the cameras always obtain the same IP addresses by permanently assigning the MAC addresses of the cameras to the desired IP addresses.

In case of an error, the camera uses its last IP address

3.3 Adjusting Lens Focus and Correcting Lens Distortion

3.3.1 Aiming and Adjusting the Lens

Make sure that you see the live image of the camera on the monitor of your computer or laptop. Now adjust the lens mount until you see the desired image area on your monitor:

- **Remove the camera dome.** Use the supplied plastic foil or a cotton cloth to remove the dome by turning it in a counter-clockwise direction. With IT/Secure models, you may have to remove the outer shell first.



- **Loosen the toothed ring slightly** by turning it in a counter-clockwise direction using the supplied hook wrench. In addition, **loosen** the two **Allen screws** on both sides of the lens mount slightly by turning them in a counter-clockwise direction using the supplied Allen wrench.



Loosen the ring and screws until you are still able to pan and rotate the internal part of the camera with the lens without much force but not so far that the lens is unable to move on its own.



- Now **aim the camera** by rotating and panning the lens mount (Note: the MicroSD card slot must point downward for the camera's live image to be displayed properly). Never use force when adjusting the direction of the camera, as this could damage the camera beyond repair.



- Once the camera has been aimed, **tighten the Allen screws** at both sides of the lens mount (in a clockwise direction) **and the toothed ring** (in a clockwise direction) with the supplied hook wrench. Do not use excessive force when doing so as this may damage the camera.
- **Adjustment: Release the lock ring of the lens** and **adjust the image focus** by rotating the lens in its socket. Check the image on the computer monitor. Make sure that you tighten the lock ring again once you are finished. To avoid damaging the lens mount, never turn the lens too far or with force.



Caution (only for 160 mm Telephoto lens)

Image Focus: Due to the lens effect of the dome, the focus of the 160 mm Telephoto lens shifts slightly once the dome has been mounted. Before mounting the dome, the Telephoto lens should be rotated by **90°-120° in a counter-clockwise direction** (against the direction in which the lens is screwed). Make sure that you check the focus of the live image with the dome installed and re-adjust the lens, if required.

- **Mount the dome.** Use the supplied foil or a lint-free cotton cloth to insert the dome into its seat and turn it in a clockwise direction. Once again, check the focus of the camera image on a computer monitor.

If required, gently clean the front of the lens using a soft cotton cloth before installing the dome. Do not apply excessive pressure to the surface of the glass when cleaning the lens.



5. **Attach the rubber seal (IT/Secure models only):** Place the rubber seal with the groove around the edge of the black mounting ring of the camera.

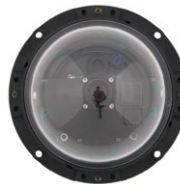

6. **Attach the outer shell (IT/Secure models only):** Replace the outer shell and screw all four Allen screws tight using the supplied Allen wrench. Ensure that the rubber seal is properly positioned.



3.3.2 Correcting Lens Distortion (L25 Only)

If you are using a D25M with the L25 82° wide-angle lens, the image, particularly the edges, may be slightly distorted due to the extreme angle of the lens.



You can suppress this effect using software (e.g. in the browser) so that a new and appropriately corrected image can be displayed live. A side effect of this correction, however, is that a cushion shape appears around the edges of the image.



To hide this cushion effect, you simply have to zoom in on the image slightly. Although this reduces the size of the captured area, the image is almost distortion-free compared to the original.

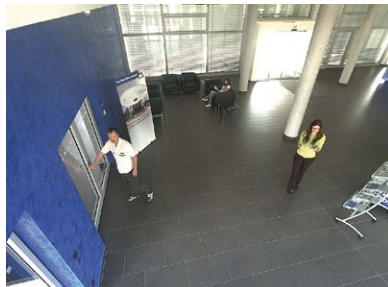

Since activated lens distortion correction requires additional processing power, you should consider disabling it in situations where it is not really necessary. You will only notice a minimal distortion of the image, especially if you use the zoom. However, the maximum frames rate for high resolution may be reduced, which means you have to choose between maximum distortion correction or maximum frame rate.

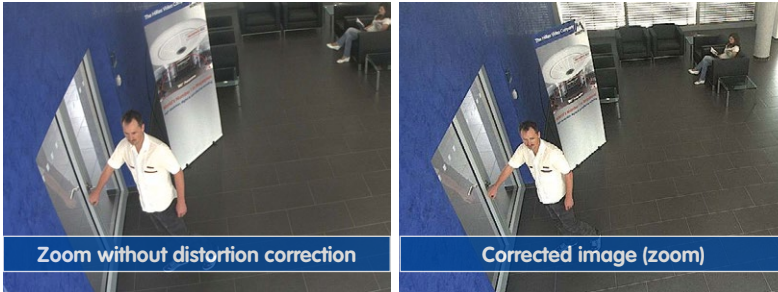

We recommend activating lens distortion correction, especially for applications with a low frame rate and non-zoomed images (e.g. when using the D25M as a webcam). However, images can usually be corrected at a later point in time when searching recorded images. This saves on processing power during recording and increases the frame rate. The more you zoom in on the image, the less distorted the image should appear.

Activate/Deactivate Lens Distortion Correction in the Browser

To activate this option, first specify the lens you are using in the **Admin Menu > Camera Administration > Lens Configuration** dialog (this setting is saved until the camera is reset to its default configuration). Select the **L25 (4.0 mm)** option from the **Lens Type Selection** field and then click **Apply** followed by **Restart**.

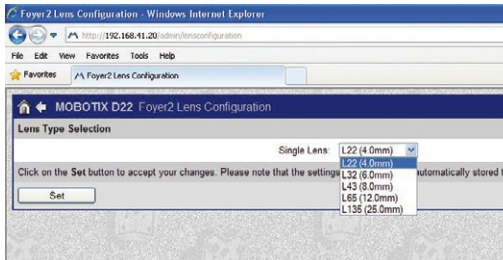

Now select the **Lens Distortion Correction** option in the **Display Mode Quick Control** panel. An automatically corrected (live) image is displayed that can be panned, tilted or zoomed. Switching to the **Full Image** option will deactivate the automatic distortion correction function.

3.4 Virtual PTZ and Full Image Recording

3.4.1 Preparing the Virtual PTZ Function

The virtual PTZ function allows you to use a mouse or joystick to continuously zoom in on images from the selected video source and "virtually" move the enlarged image section within the entire image sensor area.



USB joystick offers greater ease of use

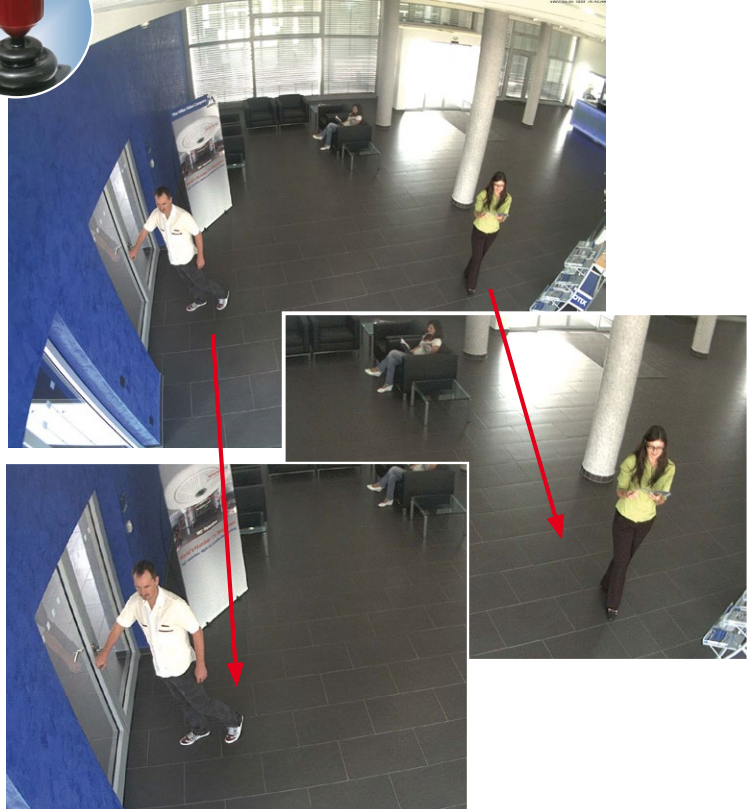

Operation Using the Mouse and Scroll Wheel

The vPTZ function of the D25M can be controlled in the browser using the mouse. By clicking any position on the image displayed on the monitor, this position becomes the new image center. The image moves and is corrected accordingly. The **scroll wheel** can be used to control the zoom function. This functionality is disabled in the default settings of the camera and must therefore first be activated. To do so, go to **Setup Menu > vPTZ Settings** and uncheck the **Lock Mouse Wheel Zoom** item. Then save the settings by

clicking **Set** and **Close**. You can now use the scroll wheel to zoom + (roll upwards) or zoom - (roll downwards).

Operation Using a USB Joystick

A standard USB joystick can drastically facilitate vPTZ operation for the user – in the browser, in MxEasy and in the MxControlCenter (however, MxCC is also equipped with a virtual joystick that can be operated using the mouse). Please first install the joystick on the PC according to the manufacturer's instructions.

In order to use a USB joystick in the browser, make sure that you have a PC with a Windows operating system and the latest version of Internet Explorer and that the **ActiveX mode in the camera software (browser) is activated**:

- Select **Browser** in the Quick Control.
- In the dropdown to the right of to **Browser**, select the **ActiveX** option. The USB joystick can then be used until the browser is closed.
- If you want to store this setting permanently, open **Admin Menu > Language and Start Page** and in **Page Options > Operating Mode**, select **ActiveX**.
- If you want to store the current settings permanently, click on **Set** and **Close** at the bottom of the dialog and approve storing the settings when prompted.
- The joystick can now be used.

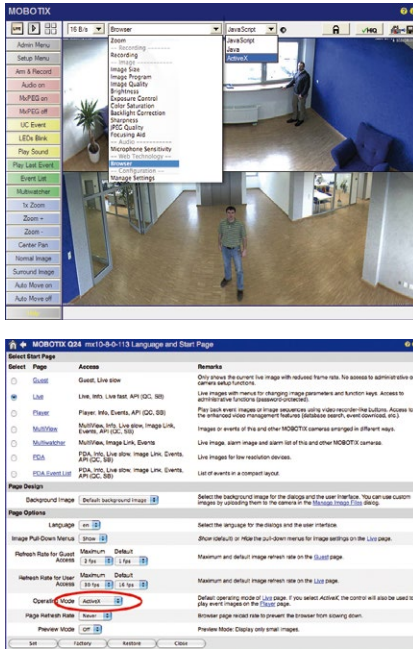

Notes

You will find more information and details on the vPTZ in the *Camera Software Manual Part 2*, under «Virtual PTZ», in the *MxEasy Manual* under «Activating the PTZ Features» and in the *MxControlCenter Manual* under «Using the vPTZ Features» and «PTZ Controls» in the sidebar panel.

The latest versions of all manuals are available at www.mobotix.com, **Support > Manuals**.

3.4.2 Full Image Recording

It is possible to record a **full image**, regardless of the live image stream that is being displayed. This ensures that the recording always contains the full image of the lens used, even though the operator may have used the vPTZ features to zoom into the image in order to examine a specific detail.

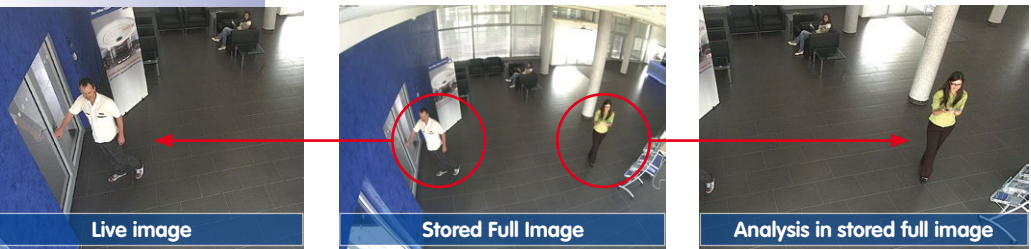

This means that you can use the vPTZ features in VGA resolution to pan, tilt and zoom the live image while the camera is e.g. recording full images at 1 fps in MEGA or QXGA resolution.

When using **MxEasy** or **MxControlCenter**, the recorded full images may be prepared for the user using vPTZ functions (e.g. panning and zooming in on an image detail such as a doorway).

If **full image storage is not activated**, only the last displayed live image will be saved (save what is seen). The **main benefit** of live image storage is to ensure that the full power of the camera processor is used for live image correction and maximum image rates.

The **main advantage of full image storage** lies in the special functionality of the D25M, in that it can always maintain availability of a maximum size (full) image for later investigation, despite vPTZ actions carried out on the live image. The mechanical limitations of motor-driven PTZ cameras mean that they simply **cannot** provide this unique advantage to the user!

Activate/Deactivate Full Image Recording in the Browser

To configure this feature, open the **Setup Menu > Event Control > Recording** dialog and activate or deactivate the “Full Image Recording” option.

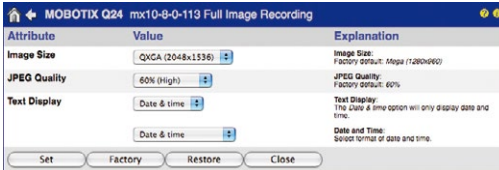
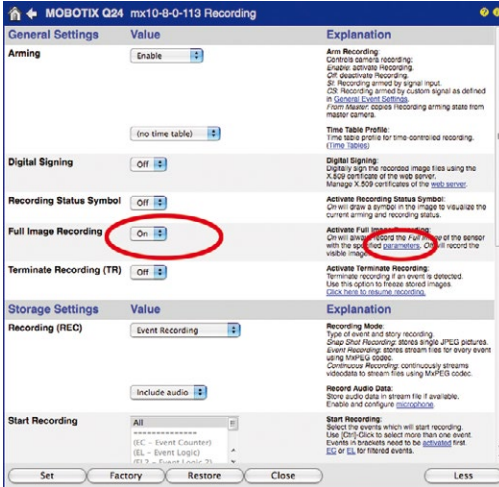

Notes

Post-event search in the full image: If you are using Full Image Recording on D25M cameras, you should use at least MEGA resolution when storing. This will facilitate later searches in **MxControlCenter** or **MxEasy**. The advanced distortion correction features require this function to deliver satisfactory image quality.

Full Image Recording On: Due to its increased computing power, full image recording reduces the data rate of the live image stream, which may drop by about 10 to 30 percent. It is therefore recommended to reduce the image rate for storage as much as possible, so as to affect the live image stream as little as possible.

Full Image Recording Off: The event that triggered a video motion (VideoMotion VM) window may not be in the recorded sequences as the window was not displayed at the time.

Flash memory devices: more robust than hard drives

3.5 MicroSD Card Recording

3.5.1 Introduction

Flash-based storage devices (MicroSD cards, USB sticks and solid-state drives) do not contain any moving parts as compared to the commonly used hard drives. Flash-based storage devices are compact and highly resistant to moisture and vibrations. They feature low energy consumption and they do not lose any data in the event of a power failure, meaning that they are ideal for use with MOBOTIX cameras.



Number of Write/Delete Cycles Per Flash Storage Cell

The number of write/delete cycles of every storage cell of a flash device is limited. The controller of the flash device automatically detects individual flash cells that are no longer functioning. The contents of the faulty cell will then be rebuilt using a checksum and will be moved to a properly working spare cell. The faulty storage cell will be marked as “bad” and will no longer be used. No data is lost in this process.

In addition, MOBOTIX cameras constantly monitor activated flash storage devices. MOBOTIX has developed a technology to test the wear of the flash device by logging the number of write/delete cycles (patent pending). The flash memory wear is automatically displayed in the status bar in the live camera image but it can also be viewed at any time in the **Admin Menu > Camera Status** dialog box.

Conservative Memory Usage Thanks to MOBOTIX MxFFS File System

MxFFS formatting of the MicroSD card means that MOBOTIX camera software will use the flash device as evenly as possible, thus allowing for the maximum possible number of write/delete cycles. This also means that all storage cells of the flash device will be written and deleted with the same frequency, if possible. MOBOTIX technology increases the life of the flash device considerably and also improves the security and the reliability of the storage process.

Storage Requirements and Life Expectancy of MicroSD Cards

The life expectancy of a MicroSD card increases proportionally to the storage capacity, since the camera software will execute fewer write/delete cycles on each storage cell. The first deletion will begin once the SD card has been filled to capacity (first full cycle).

All specifications are based on calculated averages

32 GB MicroSD Card: Storage Requirements						
	6 fps CIF		6 fps VGA		1 fps MEGA	1 fps QXGA
	M-JPEG	M-JPEG	MxPEG	M-JPEG	M-JPEG	
File size single image	15 kB	45 kB	–	120 kB	240 kB	
Storage required per second	90 kB	270 kB	75 kB	120 kB	240 kB	
Storage required per 24 hrs	7.8 GB	23.5 GB	6.5 GB	10.4 GB	20.8 GB	
Time for one full cycle	4 days	1.3 days	4.8 days	3 days	1.5 days	

4 GB MicroSD Card: Storage Requirements						
	6 fps CIF		6 fps VGA		1 fps MEGA	1 fps QXGA
	M-JPEG	M-JPEG	MxPEG	M-JPEG	M-JPEG	
File size single image	15 kB	45 kB	–	120 kB	240 kB	
Storage required per second	90 kB	270 kB	75 kB	120 kB	240 kB	
Storage required per 24 hrs	7.8 GB	23.5 GB	6.5 GB	10.4 GB	20.8 GB	
Time for one full cycle	12 hours	4 hours	14.4 hours	9.2 hours	4.4 hours	

Caution

The MicroSD card's service life depends on production quality and frequency of use. Set the type of recording (event-controlled or continuous recording, frame rate, resolution) according to your specific requirements.

We recommend changing the pre-installed, high-quality 4 GB MicroSD card once a year if you have it constantly set to continuous recording.

Monitoring the Cell Wear of Flash Storage Devices (Patent Pending)

MOBOTIX uses its own technology for this purpose and has a pending patent. You can view the flash wear in the status bar of the live image or by opening **Admin Menu > Camera Status**. In addition, the camera can also send a warning message (for example, via e-mail) as soon as a critical error is detected when data is written to the SD card (**Admin Menu > Error Notification Function**.). The MicroSD card can then be replaced to ensure that any existing data is not lost.

File Server / Flash Device	
Type	SD Flash Card
File System	MxFFS
Flash Wear	1%
Transfer Buffer Usage	0% (0: 0%, max: 0%)
Lost Event Images	0
Sequences	1 (1 files)
Newest Sequence	1970-01-01 01:00:00 #0
Oldest Sequence	1970-01-01 01:00:00 #0
Current Usage	4.0 MBytes (0.4%)
Max. Size	936 MBytes

Format SD card:
Admin Menu > Storage
on External File Server
/ Flash Device

3.5.2 Formatting the MicroSD Card

Before a MOBOTIX camera can store image and video sequences on a MicroSD card, the card needs to be formatted as MxFFS (MicroSD cards supplied by MOBOTIX are already MxFFS-formatted). The following steps are necessary to format a storage device (**Admin Menu > Storage on External File Server / Flash Device**):

1. Make sure that there is a MicroSD card in the card slot of the MOBOTIX camera.

2. Click **Format** in the **SD Memory Card** line.

3. Note down the characters shown in the **Encryption password** field or enter your own password. Next, click **OK**.

Note: The **Secure deletion – Slow** option will ensure that any data on the MicroSD card is overwritten completely so that the data cannot be recovered in any way. However, keep in mind that this kind of safe formatting takes considerably more time.

4. In the next dialog box, enter the user name and the password of a user of the **admins** group and click **OK** to confirm.

The MOBOTIX camera now starts formatting the card. It takes 5 to 12 minutes to format an 8 GB MicroSD card if the **Secure deletion – Slow** option is disabled. If **Secure deletion – Slow** is enabled, this may take anywhere between 3 and 14 hours.

Once the formatting has been completed, you can activate the MicroSD card for recording (see next section).

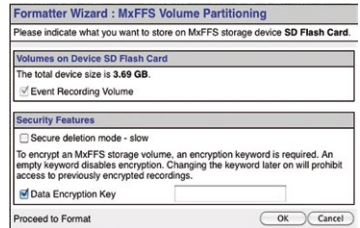
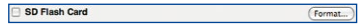

Caution

Make sure that you always wait until the formatting process has been completed before accessing the camera again. If the **Secure deletion – Slow** option is disabled, this usually takes just a few minutes. You can only access the MicroSD card once MxFFS formatting has been completed.

Formatting with the **Secure deletion – Slow** option enabled takes several hours. You can also use suitable applications on Windows, Linux/UNIX and Mac OS X systems to repartition and safely erase the MicroSD card.

3.5.3 Activating MicroSD Card Recording

Follow these steps to activate the recording to a MicroSD card that has already been MxFFS-formatted (**Admin Menu > Storage on External File Server / Flash Device**):

1. Make sure that there is a MicroSD card in the card slot of the MOBOTIX camera.
2. Make sure that the MicroSD card is formatted in MxFFS format.
3. Activate the **SD Flash Card** option.
4. Click on **Set** and then **Close** to store the configuration.
5. Reboot the MOBOTIX camera (**Admin Menu > Reboot Camera**).

Once the camera has rebooted, make sure that the camera displays the **FR REC** symbols in its live image. If this is the case, the camera uses the MicroSD card as recording target. If not, you must activate the recording (see below).

Activating the Recording

If the **FR REC** symbols are not visible in the live image after rebooting, you need to activate the recording using one of the following methods:

- **In the web browser:** Automatic activation by clicking on the **Arm & Record** softbutton. Confirm this in the Easy Dialog by clicking on the **Yes** button.
- **In the web browser:** Manual activation via the Quick Control **Recording > Recording on** or in **Setup Menu > Recording**.
- **MxEasy:** It is possible to activate the recording based on the time or date using the Alarm Planner of MxEasy (see *MxEasy User Manual*).

Encryption and Authentication

All video data stored on the MicroSD card is encrypted to ensure security at all times. The password for this is defined during the card's formatting procedure and needs to be entered for authentication whenever the recordings are accessed (see next section).

Activate recording:
**Admin Menu >
Storage on External File
Server / Flash Device**

3.5.4 Accessing Data on the MicroSD Card

The following options facilitate access to the stored image and video sequences on a MicroSD card:

- **In the web browser:** Play back the recorded event images without audio directly from the MicroSD card using the Playback view of the camera software.
- **In MxEasy:** Play back the recorded video sequences with audio by accessing the MicroSD card in the MOBOTIX camera via the camera.
- **In MxControlCenter:** Play back the recorded video sequences with audio by accessing the MicroSD card in the MOBOTIX camera via the camera or with a direct access to the MicroSD card via a card reader connected to the computer. Access the card by setting the MicroSD card's drive/volume as a **directory** in MxControlCenter.

If the recordings stored on the MicroSD card were encrypted, you need to enter the password used for the encryption before you can access the data. If this is the case, both MxControlCenter and MxEasy will provide a dialog box for this purpose.

Caution

When **using the MicroSD card from one MOBOTIX camera in another MOBOTIX camera**, you need to make sure that the time on the original camera is in sync with the new camera. We recommend using automatic time synchronization via a time server (**Admin Menu > Date and Time**).

3.5.5 Deactivating Card Recording

Follow these steps to deactivate the memory on a MicroSD card (**Admin Menu > Storage on External File Server / Flash Device**):

1. Activate the **None** option.
2. Click on the **Set** button at the bottom of the dialog box and then on **Close**.
3. Reboot the MOBOTIX camera (**Admin Menu > Reboot Camera**).

Once the camera has rebooted, make sure that the symbol **FR REC** is no longer visible in the bottom right-hand corner of the live image. You can now safely remove the MicroSD card from the camera (see *Section 2.8, «Replacing the MicroSD Card»*).

Caution

A **MicroSD card may only be removed from the camera after you have deactivated the recording** to MicroSD card and **rebooted the camera**. **Failing to do so may lead to data loss!**

Removing connected flash storage devices from the camera without properly deactivating them may lead to data loss and/or destroy certain areas of the storage device. This is limited to 4 MB of lost data per incident due to MxFFS formatting.

3.5.6 Using a MicroSD Card in a Different MOBOTIX Camera

A MicroSD card containing recorded video data from a MOBOTIX camera can be inserted into any MicroSD card-enabled MOBOTIX camera. Once a MicroSD card recording has been activated (requires a reboot), the “new” MOBOTIX camera automatically synchronizes with the card and resumes recording. No data is lost in this process. Make sure that you deactivate MicroSD card recording before removing the card and then reboot the MOBOTIX camera.

If the MicroSD card’s contents are encrypted, you need to enter the same password in the “new” camera in the **Admin Menu > Storage on External File Server / Flash Device** dialog box. Otherwise, the camera cannot access the MicroSD card.

3.5.7 Limitations on Warranty When Using Flash Storage Media

MOBOTIX will not assume any responsibility for flash storage devices (for example, MicroSD cards or connected USB storage devices) delivered with or integrated into MOBOTIX cameras. The same applies to damage to flash storage devices or damage resulting from the use of devices that are not supplied by MOBOTIX.

3.6 Configuration in the Browser

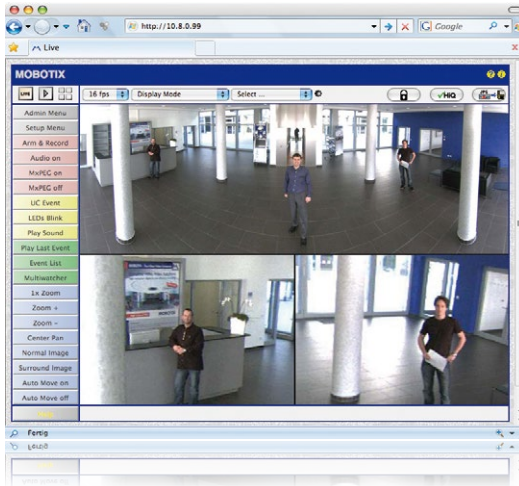

3.6.1 Overview

A MOBOTIX camera can be completely configured using a JavaScript-enabled browser on all common operating systems (such as Windows, Linux, Apple, etc.). The camera provides a HTML-based user interface for this purpose. The camera executes the changes you make to the camera configuration via HTTP commands using programs and scripts of the embedded software. The settings are stored in the camera's flash memory.

This section contains an overview of the basic browser settings of the MOBOTIX camera as well as further configuration options. Detailed information on the software functions is provided in the camera's online help.

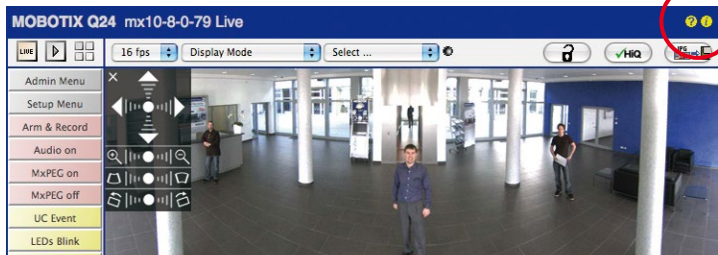

Basic Settings

- **Administering the camera:** You can modify the camera configuration in the Admin Menu or the Setup Menu.
 - **Admin Menu:** This menu contains the basic configuration dialog boxes of the camera (for example, passwords, interfaces, software updates).
 - **Setup Menu:** This menu contains the dialog boxes for configuring the image, event and recording parameters. Some of these settings can be changed using the corresponding Quick Controls in the live view.
- **Resetting changes:** If you would like to reset some larger changes in one dialog box without resetting the complete configuration, you can use the **Default** button at the bottom of the dialog box to reset only this dialog box's settings to the factory defaults. If you would like to reset all image settings, you can do so using the **Manage Settings > Restore Image Settings** Quick Control in the live image of the camera.
- **Storing changes permanently:** Once you have finished configuring the camera, you should always store the settings in the camera's permanent memory. You can do so in each dialog box (clicking on the **Set** button at the bottom of each dialog box will temporarily implement the change; when you click **Close**, you will be asked to store the complete configuration in the camera's permanent memory) or in the Admin Menu (**Admin Menu > Store current configuration into flash memory**). The **Configuration** section of the Admin Menu provides more functions for storing, copying and managing camera settings. For more information on this topic, refer to the online help for the specific dialog boxes.
- **Time tasks and time synchronization:** Apart from a multitude of possibilities for controlling the camera using time (time tables, holiday and vacation, scheduled tasks, etc.), the camera can also synchronize its internal clock. This allows you to manually synchronize the camera with a computer or automatically using a time server or another MOBOTIX camera. The camera can use either NTP time servers or Time Protocol servers. For more information on this topic, refer to the online help for the specific dialog boxes.
- **The "More" and "Less" buttons:** When opening some of the camera dialog boxes, the camera only shows the most important parameters. These dialog boxes have a **More** button in the bottom right-hand corner. Click it to display additional options. If all options are displayed, click on the **Less** button to hide the additional options.

User name: **admin**
password: **meinstm**

Admin Menu

Setup Menu

Make sure to permanently store changed parameters!

Automatic time synchronization using a time server

More: Display advanced features

Less: Hide advanced features

3.6.2 General Browser Settings

- **Run the Quick Installation:** After booting a new MOBOTIX camera, accessing the administration menu for the first time will automatically start the Quick Installation assistant (**Admin Menu** button). The Quick Installation assistant helps you in setting the most important parameters of the camera. For security reasons, you should set your own administrator password and disable public access to the camera.
- **Disable public access:** Guest users are only allowed to access the Guest screen of the camera without entering a password. If this is not required, you should deactivate public access (**Admin Menu > Quick Installation** or **Admin Menu > Users and Passwords**).
- **Add users and assign access rights:** Similar to a computer operating system, you can add users and user groups and assign the desired rights (**Admin Menu > Users and Passwords**, **Admin Menu > Group Access Control Lists (ACL)**). This approach allows individual access rights to be assigned or denied to camera-specific features based on the user groups.
- **Deactivate the automatic reboot:** In its factory state, every MOBOTIX camera will automatically reboot at 3:36 a.m. every day. All images in the camera's storage buffer will be deleted during this reboot. Images stored on external file servers, internal flash storage, or SD cards will NOT be affected by this reboot. Make sure that you deactivate the automatic reboot if this is not desired (**Admin Menu > Time Tasks**).
- **Optimize the image settings:** The factory image settings of MOBOTIX cameras deliver excellent images for most application scenarios and should therefore not be changed. If you do wish to make changes, your changes should be minor and gradual. You should, however, set an image program according to the application scenario of the camera. Image programs provide a quick and simple method for adjusting the camera to the application scenario as they perform several configuration steps at once (**Image Programs** Quick Control).
- **Set the resolution of the live image:** By default, all MOBOTIX cameras are factory-set to an image resolution of 640 x 480 pixels. You can select the desired resolution using the **Resolution** Quick Control.
- **Adjust the exposure:** The automatic exposure control of the MOBOTIX camera uses individually configurable exposure windows to determine the best image exposure. Open the **Exposure Control** Quick Control and select a predefined set of exposure windows. If required, you can also define custom exposure windows (**Setup Menu > Exposure Settings**).
- **Activate event control and recording:** By default, the MOBOTIX camera's event control is disabled. Click on the **Arm & Record** button to activate event control. This will activate motion detection and recording. Cameras with integrated flash memory (MOBOTIX R models and models with an SD card) will automatically use the flash memory to store image and video data (recording target). If desired, you can set additional events and adjust the settings of the recording and storage parameters (**Setup Menu > Event Settings**, **Setup Menu > Recording** and **Admin Menu > Recording to External File Server / Flash Device**).

- **Set up actions/messaging:** Upon detecting an event, the MOBOTIX camera can trigger alarms. These alarms can be adjusted to your needs and you can assign them to a specific event: playing back an alarm sound on the camera speaker, showing the visual alarm in the camera live image, sending an e-mail or network message with the alarm image, placing a phone call, uploading an alarm image to an FTP server, switching a signal output line of the camera (for example, for switching on the lights/opening a door).

For the settings, see **Setup Menu > Action Group Overview**. The actions to be performed are defined and used in these action groups in the form of “action profiles.” The different action profiles can also be defined in the following areas: Admin Menu in the Hardware Configuration (profiles for signal output), Transfer Profiles (FTP, e-mail, network messages) and Sound and VoIP Telephony (sound profiles, VoIP profiles). For more information, refer to the online help for the **Action Group Overview** dialog box.

- **Activate shock detector:** The D25M is also equipped with a shock detector as standard (for all IT and Secure models). If, for example, the camera’s housing receives a blow, it automatically registers it and sends a notification via a network message or telephone call. A general advantage is that MOBOTIX cameras are extremely tough because of the absence of mechanical moving parts. This allows them to stay fully operational when they are subject to strong vibrations. Open the **Setup Menu > Event Control > Environment Events > Edit** dialog box if you would like to activate the shock detector (and any other sensors).

3.7 Additional Notes

3.7.1 Weatherproofness

The MOBOTIX D25M IT/Secure models have been certified weatherproof according to IP65 (absolutely dust-proof and resistant to water jets) and can also be wall-mounted outdoors. The MOBOTIX D25M Basic has attained a protection class of IP54.

3.7.2 Password for the Administration Menu

Accessing the administration menu of the camera (Admin Menu button) is only possible after entering a user name and password.

- Factory default user name is **admin**
- Factory default password is **meinsm**

The Quick Installation assistant automatically appears when the administration menu is accessed for the first time. It provides an easy method to adjust the basic camera settings to the current application scenario. For security reasons, it is highly recommended to change the default administrator password after the camera has been properly configured.

Enter the user name and password exactly as shown above. Note that all entries are case-sensitive.

Caution

Make sure that you store information on user names and passwords in a secure place. If you lose the administrator password and cannot access the Administration menu, the password can only be reset at the factory. This service is subject to a service charge!

3.7.3 Permanently Deactivating the Microphone

Deactivating a camera's microphone may be necessary in order to protect the privacy of persons at a workplace or for other reasons. You can permanently and irreversibly deactivate the microphone in the **Admin Menu > Loudspeaker and Microphone** dialog box.

3.7.4 Starting the Camera with the Factory IP Address

If the camera's IP address is not known, you can start the camera with its factory IP address. *Section 3.2.5, «Starting the Camera with the Factory IP Address»* describes this procedure in more detail.

The microphone can be irreversibly deactivated!

3.7.5 Resetting the Camera to Factory Settings

All settings of the MOBOTIX camera can be permanently reset to the factory default settings. This makes sense if, for example, you have obtained a camera without any information or you would like to reset all settings after testing the camera. In order to perform this procedure, you need to have access to the administration area of the camera (admins group). Open **Admin Menu > Reset** to reset the camera to factory defaults.

Note

All defined users are deleted and the admin password is reset to the factory default when you reset the camera using **Admin Menu > Reset**. If you want to maintain the existing users, use the method described in *Section 3.2.5, «Starting the Camera with the Factory IP Address»*.

3.7.6 Activating Event Control and Motion Detection

In its default configuration, the camera's event control and video motion detection features are not enabled. In order to activate event-controlled recording, open **Setup Menu > General Event Settings** and activate the Arming switch. Another method is to click on the **Arm & Record** softbutton in the browser's user interface. The camera displays the motion detection window in the live image (dotted frame in the center) and the camera automatically stores images as soon as the motion detection window detects movements.



If the dotted rectangle in the live image is visible, the camera is armed

3.7.7 Deactivating Text and Logo Options

As camera arming is deactivated in the camera's default configuration (see preceding section), the MOBOTIX camera only displays the text `www.mobotix.com`, the time stamp and the MOBOTIX logo at the top of the image. Once the camera arming has been activated, the text at the bottom of the live image (event, action, messaging and recording symbols) will also appear.

You can deactivate the status bar at the bottom of the live image and the text bar in the top left-hand corner by setting Text Display in the **Setup Menu > Text & Display Settings** dialog box to **Off**. Setting Text Display to **Date and Time** will only display the time stamp in the live image. To hide the logo in the live image, open **Admin Menu > Logo Profiles** and set **Logo Display** to **Deactivated**.

Text and logos can be also deactivated or individually configured

3.7.8 Deactivating the Camera Reboot

By factory default, the MOBOTIX camera automatically reboots once a week between 3 a.m. and 4 a.m. The reason for this is that in some rare cases, external influences (for example, radiation at high altitudes) can sometimes lead to camera malfunctions. The automatic reboot will refresh the camera's memory and will ensure proper operation without requiring any interaction on the part of the user. If desired, you can deactivate the automatic reboot of the camera in the **Admin Menu > Time Tasks** dialog box.

3.7.9 Browser

Current Internet browsers (Internet Explorer, Mozilla Firefox, Safari, Google Chrome, Opera, etc.) with enabled JavaScript can display the camera's live images with their standard settings.

3.7.10 Cleaning the Camera and Lens

If the lens becomes dirty during the installation process, clean the lens using a lint-free cotton cloth. Make sure that the lens is still in focus after cleaning and adjust its focus if required.

Cleaning the Dome:

- In order to protect the dome from being scratched and from getting dirty, only handle the dome using a soft cotton cloth or the protective plastic of the camera's shipping box.
- You should clean the dome at regular intervals. Always use a soft, lint-free cotton cloth for this purpose.
- If the dirt is more persistent, add a mild alcohol-free detergent without abrasive particles.
- Make sure you instruct cleaning personnel on how to clean the camera.

3.7.11 Legal Notes

Legal aspects of video and sound recording: You must comply with all data protection regulations for video and sound monitoring when using MOBOTIX products. Depending on national laws and the installation location of the D25M, the recording of video and sound data may be subject to special documentation or it may be prohibited. All users of MOBOTIX products are therefore required to familiarize themselves with all valid regulations and comply with these laws. MOBOTIX AG is not liable for any illegal use of its products.

3.7.12 Safety Warnings

Installation Instructions:

- This product must not be used in locations exposed to the dangers of explosion.
- Make sure to install this product as shown in *Chapter 2, «Installation»* of this manual.
- When installing this product, make sure that you are only using genuine MOBOTIX parts and MOBOTIX connection cables.
- Make sure that you are installing this product on a solid surface that provides for a sturdy installation of the fixing elements used.

Electrical installation: Electrical systems and equipment may only be installed, modified and maintained by a qualified electrician or under the direction and supervision of a qualified electrician in accordance with the applicable electrical guidelines. Make sure to properly set up all electrical connections.



Electrical surges: MOBOTIX cameras are protected against the effects of small electrical surges by numerous measures. These measures, however, cannot prevent the camera from being damaged when stronger electrical surges occur. Special care should be taken when installing the camera outside of buildings to ensure proper protection against **lightning**, since this also protects the building and the whole network infrastructure.

Max. power consumption of attached extension modules: The power consumption of all attached **MxBus modules** must **not exceed 2.5 W**. When attaching modules to the MxBus connector **and** the USB connector, the **power consumption of all attached modules must not exceed 3 W, if the camera is powered by PoE class 3**. If **PoE class 2** is used, **the power consumption of all attached modules must not exceed 1 W!**

Never touch the lens: Due to the high performance of the D25M, the area of the image sensor **can get quite hot**, especially when the ambient temperature is also high. This does not affect the proper functioning of the camera in any way. For this reason, the product must not be installed within the reach of persons without the dome.

Power off before opening the camera: Make sure the power supply is disconnected before opening the camera (i.e., for installing or replacing sensor modules and SD cards).

Network security: MOBOTIX products include all of the necessary configuration options for operation in Ethernet networks in compliance with data protection laws. The operator is responsible for the data protection concept across the entire system. The basic settings required to prevent misuse can be configured in the software and are password-protected. This prevents unauthorized parties from accessing these settings.

3.7.13 Online Help in the Browser

For more information, see the News and Functional Overview pages in the online help of the camera's browser interface. Click on the **?** icon to open the camera's online help. Furthermore, detailed information on the camera and its current configuration is displayed in the **Camera Status** dialog box. Click on the **i** icon to open the relevant page.

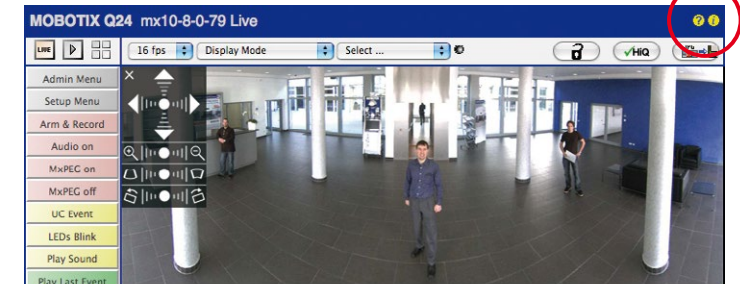

3.7.14 Declaration of Conformity

The products of MOBOTIX AG are certified according to the applicable directives of the E.U. and other countries. You can find the declarations of conformity of the products of MOBOTIX AG under www.mobotix.com, **Support > MX Media Library > Certificates > Declarations of Conformity**.

3.7.15 Disposal



Electrical and electronic products contain many reusable materials. For this reason, we would ask that you dispose of MOBOTIX products at the end of their service life in accordance with all legal requirements and regulations (or deposit these products at a municipal collection center). MOBOTIX products may not be disposed of with household waste! If the product contains a battery, please dispose of the battery separately (the corresponding product manuals contain specific directions if the product contains a battery).

3.7.16 Disclaimer

MOBOTIX AG does not assume any liability for damage that is the result of improper use of its products or failure to comply with the operating manuals or the applicable rules and regulations. Our **General Terms and Conditions** apply. You can download the current version at www.mobotix.com (using the COS link at the bottom of each page).

Notes





To demonstrate our confidence in the quality of our products, MOBOTIX cameras have been used to capture all images that appear in this manual.

Manufacturer

MOBOTIX AG
Kaiserstrasse
67722 Langmeil
Germany

Phone: +49 6302 9816-103

Fax: +49 6302 9816-190

www.mobotix.com

sales@mobotix.com

Registration Office: Kaiserslautern Local Court

Registration Number: HRB 3724

Tax Office: Worms-Kirchheimbolanden, Germany

Tax Code: 44/676/0700/4

VAT ID: DE202203501

You can find the latest version of this and other documents (e.g., declarations of conformity) at www.mobotix.com in the **Support** section.



Technical specifications subject to change without notice!



Fits In. Watches Out.

The D25M Dome camera adapts perfectly to any task. Exchangeable lenses, various mounting and configuration options including Vandalism Set support unlimited possibilities.



Outdoor Wall Mount



On-Wall Set 0°



On-Wall Set 10°



In-Ceiling Set



Vandalism Set

5 MP
Sensor

MxLEO



vPTZ



MxBus

USB

+50°
-30°

IP65



Innovations – Made in Germany

The German company MOBOTIX AG is known as the leading pioneer in network camera technology and its decentralized concept has made high-resolution video systems cost-efficient.

MOBOTIX AG • D-67722 Langmeil • Tel: +49 6302 9816-103 • Fax: +49 6302 9816-190 • sales@mobotix.com